



Eurobot 2009

# Temples of Atlantis



---

Rules 2009

---



## Temples of Atlantis

*The robot who builds the tallest columns and temples  
will be declared the winner.*



## Rules 2009

### Table of Contents

- 1. Introduction..... 4
- 2. General notes..... 5
  - 2.1. Rules scope .....5
  - 2.2. Event schedule.....5
  - 2.3. Refereeing .....5
- 3. The 2009 theme ..... 6
  - 3.1. The theme .....6
  - 3.2. Playing elements .....7
    - 3.2.1. Tolerances.....8
    - 3.2.2. Limitation of controlled elements .....8
    - 3.2.3. Constructions .....8
  - 3.3. Playing area .....9
    - 3.3.1. Tolerances.....10
    - 3.3.2. Starting zones.....10
    - 3.3.3. Borders.....10
    - 3.3.4. Beacon supports .....10
  - 3.4. Building areas .....11
  - 3.5. Dispensing zones.....12
    - 3.5.1. Column element dispensers .....13
    - 3.5.2. Lintel storage .....13
    - 3.5.3. Pre-loaded lintel .....14
    - 3.5.4. Free elements .....14
  - 3.6. Scoring.....15
    - 3.6.1. Game points.....16
    - 3.6.2. Destruction compensation .....17
    - 3.6.3. Penalties.....17
    - 3.6.4. Match points .....17
- 4. The robots..... 18
  - 4.1. General conditions ..... 18
  - 4.2. Robot dimensions..... 18
  - 4.3. Visibility..... 19
  - 4.4. Limitations..... 19
    - 4.4.1. Fair-play ..... 19
    - 4.4.2. Limitation of controlled game elements..... 20
    - 4.4.3. Usage of fans..... 20
  - 4.5. Mandatory equipments ..... 20
    - 4.5.1. Starting cord ..... 20
    - 4.5.2. Emergency stop button ..... 20
    - 4.5.3. Automatic shut down..... 21
    - 4.5.4. Obstacle avoidance system..... 21
    - 4.5.5. Robot localization beacon support..... 21
    - 4.5.6. Technical poster..... 21



---

## Rules 2009

---

4.6.	Energy sources .....	22
4.7.	Control systems .....	22
4.8.	Safety .....	23
4.8.1.	On-board voltage .....	23
4.8.2.	Lasers .....	23
4.8.3.	Powerful lights .....	24
4.8.4.	Compressed air systems .....	24
4.9.	Other systems .....	25
5.	Beacons .....	26
5.1.	General comments .....	26
5.2.	Robot localization beacon .....	27
5.3.	Fixed beacons .....	27
5.4.	Communication signals .....	27
6.	Match timeline .....	28
6.1.	Robot identification .....	28
6.2.	Starting procedure .....	28
6.3.	Match sequence .....	29
6.4.	Calculation of the score .....	29
6.4.1.	Game points .....	29
6.4.2.	Penalty points .....	29
6.4.3.	Match points .....	30
6.4.4.	Scratch and match disqualification .....	30
6.4.5.	Competition disqualification .....	30
7.	Competition phases .....	31
7.1.	Approval phase .....	31
7.1.1.	Physical examination and team interview .....	31
7.1.2.	Practical trials .....	31
7.1.3.	Modifications after approval .....	32
7.2.	Qualification rounds .....	32
7.3.	Final round .....	32
8.	Appendix A - Playing area and elements specifications .....	34
8.1.	Tolerances .....	34
8.2.	Technical drawings of the table and the playing elements .....	34
8.3.	References of the paints .....	35
9.	Appendix B - Random cards .....	36
10.	Appendix C - Technical drawings .....	39



Eurobot 2009

# Temples of Atlantis



---

## Rules 2009

---

### 1. Introduction

---

Eurobot is an amateur robotics contest open to groups of young people from around the world, organised in teams. These teams could be formed from students as part of their studies or as independent clubs or non-profit organizations. A team must be made up of two or more active participants. Team members may be up to 30 years old, each team may have one supervisor for which this age limit does not apply.

The aims of the contest are to favour the public interest in robotics and encourage hands-on practice of science by young people. Eurobot is intended to take place in a friendly and sporting spirit.

More than a simple championship for young people or a competition, Eurobot is a friendly opportunity to unleash technical imagination and exchange ideas, know-how, hints and engineering knowledge around a common challenge. Creativity and interdisciplinary is necessary. Eurobot values fair play, solidarity, creativity and sharing of technical knowledge, whether it is across technical realisations or project management.

Eurobot takes place in Europe, but is open to teams from other continents. Countries with more than three teams interested in participating must organise a national qualification in order to select the three teams which will participate to Eurobot finals. The selection will typically include the two best teams (in terms of competition score), but it is left to each national organisation committee to agree on a possible alternative to competition for selecting its last team. For example, the third team can be chosen by a jury according to other qualities valued by the contest, such as: best concept, most creative, fair-play, etc. Note that for countries failing to establish a national qualification event, but with more than 3 teams registered to Eurobot, the refereeing committee will accept only the three teams to the event, selecting based on the order of registration.

Eurobot was born in 1998, in the wake of the French Cup of Robotics, following the constitution of a similar competition in Switzerland. To deal with the expansion of the contest and to maintain the original spirit of exchange and cooperation between the different organisers, an association was founded.

This association, officially born on May 24th 2004, is named EUROBOT. You can find its statutes on our website ([www.eurobot.org](http://www.eurobot.org)). Individuals or organisations sharing our values are most welcome to support us either financially, or by joining us as volunteers in one of the different organising groups.

Eurobot and the national qualifications are prepared with passion throughout the year by persons of many nationalities, volunteers for most of them, which believe in the educational values of this experience and are themselves, often former participants.

Welcome!

And have a nice adventure!



## 2. General notes

---

### 2.1. Rules scope

The following rules apply to all national qualifications and to the finale of the 2009 edition of the Eurobot autonomous robots competition.

In addition, Eurobot Association has the right to issue more detailed specifications and restrictions to the rules for a specific country (based on its National organizer request), and the teams competing in that country have to adhere them. We would like to alert the teams that this applies both to their local cups as well to the international finale - all teams which promote to the finale have to meet the specifications issued for the country where the finale is held; if they do not follow them, they would not be allowed to compete. As an advice, it would be very wise to study this before the works on the robot start and build the robot in conformance with both local country and current year finale country additions.

### 2.2. Event schedule

The qualified teams from the national cups of Algeria, Austria, Belgium, Czech Republic, France, Germany, Great Britain, Italy, Romania, Russia, Serbia, Spain, Switzerland and of all other new national qualifications born in 2009, will meet their international counterparts (multinational teams and teams from countries without qualifications) during the Eurobot final from **Wednesday, May 20th to Sunday, May 24th, 2009, in the city of La Ferté Bernard (France).**

It is important to note that most of the national competitions, within the limits of their means, are opened to the foreign teams, Moreover, numerous teams organize their own friendly competitions. Multinational teams are obviously very welcome.

### 2.3. Refereeing

Each match is supervised by two referees. For all the matches of the Eurobot finals, at least one of the two referees will be from a country different from both of the competing teams.

The referees are intended to interpret and apply the rules during the approvals and the competition but they are also there to help the teams, by clarifying points for instance. You are encouraged to contact the referees with questions about the rules or the competition process.

Participating to the competition implies the acceptance of the rules and the interpretations of them made by the refereeing committee throughout the year and by the referees during competition matches. The referees' decisions are final and may not be challenged.



Eurobot 2009

# Temples of Atlantis



---

Rules 2009

---

## 3. The 2009 theme

---

### 3.1. The theme

After playing rugby, bowling, sorting rubbish and collecting samples on Mars, this year we are going back in time and travelling to Atlantis. Our robots will become builders and will help the people from Atlantis to build wonderful temples of which we could today visit the ruins... if we had discovered where Atlantis is hidden. As many antique temples, the buildings are made of columns with lintels connecting them to top up the construction. Moreover, in order for their buildings to be closer to the gods, the Atlantean people built them on the highest hills of their continent.

The matches involve two teams, one playing green, and the other red. Each team may enter only one temple building robot. The robot that builds the tallest temples will be the winner. **The matches last 90 seconds.**

The robots begin in the starting zones of their colour, located in one of the back corners of the table. The coloured playing elements are available for the robots in different places on the table, either on the ground in predefined positions or in dedicated dispensers. The constructions must be built in one of the several scoring zones, determined by a colour different from the rest of the table. The scoring zones are placed in levels of different heights. The points are given according to the height of the buildings, their composition as well as to the height of the zone where they were built.

It is important to note that this year's theme orients towards construction, and as a consequence, any action of destruction (intentional or not) will be penalised.

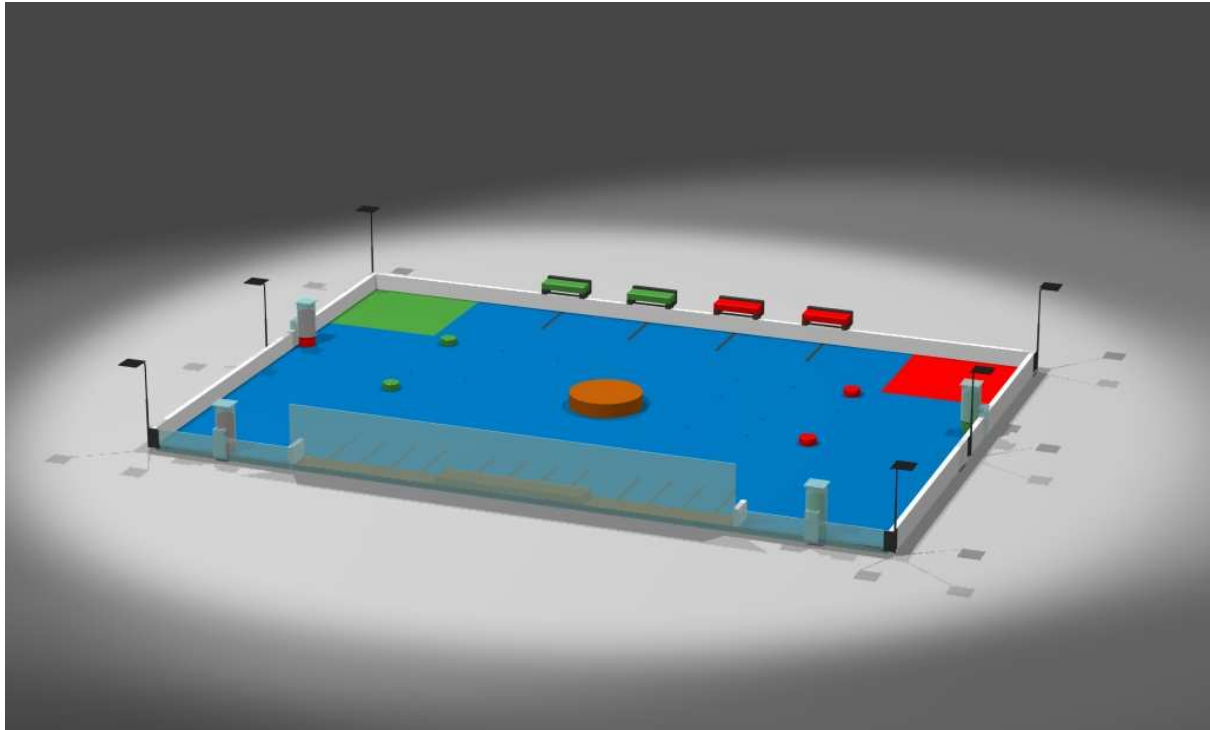

All drawings of this document are designed with SolidWorks software



Please note that the name and description of this year's theme are simply a fanciful title for what is, in essence, a scientific and educational competition, whose main theme is autonomous mobile robotics, not Atlantis. We do not endorse any particular views on the subject of Atlantis, nor do we wish to offend anyone by this choice of theme. Any connection to existing persons, organisations or works involving Atlantis is not intentional.

## 3.2. Playing elements

The playing elements for this year's theme are the building elements for temple construction:

- The **column elements** are wooden cylinders 30 mm high with a diameter of 70 mm. They weigh approximately 100 gr.
- The **lintels** are wooden boxes which are 200 mm long, 70 mm wide and 30 mm high. They weigh approximately 300 gr.
- All elements are cut with a slight chamfer along all edges, 2 mm cut at 45°.



---

## Rules 2009

---

The elements are painted in the team colours. The references of the colours are given in section “*References of the paints*” on page 35.

The following building elements are available in the dispensing zones (for details about these zones, refer to *Dispensing zones* on page 12) :

- 16 red column elements,
- 16 green column elements,
- 2 red lintels and one optional pre-loaded red lintel,
- 2 green lintels and one optional pre-loaded green lintel.

### 3.2.1. Tolerances

As detailed in paragraph “*Tolerances*” on page 4, the tolerances for playing field element construction are 5% of each dimension.

### 3.2.2. Limitation of controlled elements

The robots can control at maximum **4 column elements** at a time.

**Controlling** a playing element by a robot means directly and intentionally influencing its trajectory through the robot's motion. This rule applies to all the robot's mechanisms, regardless of whether the manipulation is internal or external.

The number of carried **lintels** is **not limited**. However, the robot may only carry lintels of its own colour.

The teams are encouraged to make all the carried elements visible from the outside. The aim of this advice is pedagogic above all, allowing the public and other contestants to see how the actions of the robot are carried out.

### 3.2.3. Constructions

The constructions made by the robots may be:

- **Columns:** simple stacks of the cylindrical column elements; it is important to note that a single column element is considered as the beginning of a column.
- **Temples:** constructions composed of two columns linked by a lintel

The columns as well as the temples can be made of elements of different colours, each of them being added to the score of the corresponding team, according to the rules detailed in paragraph “*Scoring*” on page 15.

In order for points to be awarded, the buildings must be constructed within defined areas, detailed in paragraph “*Building areas*” page 11.



### 3.3. Playing area

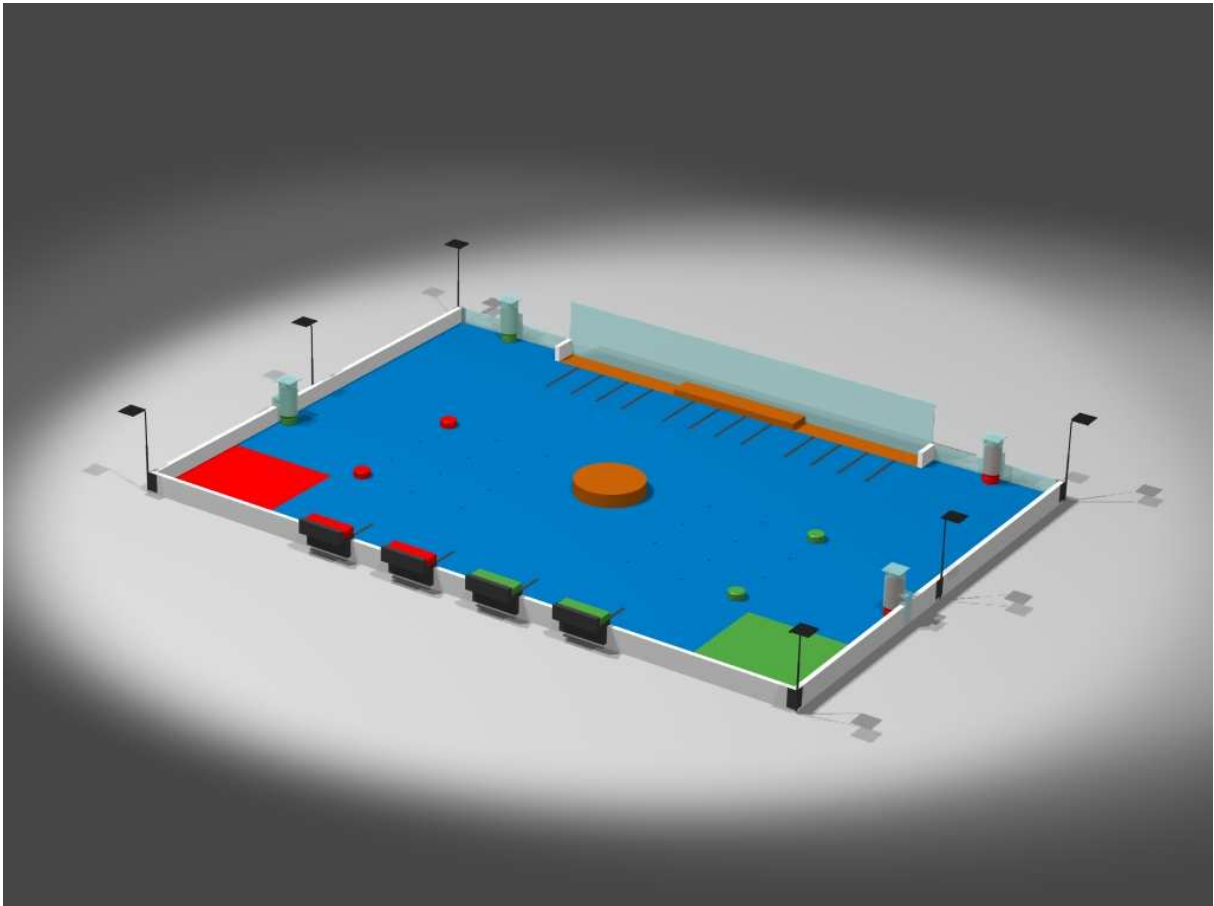

The playing field is **2100 mm** wide and **3000 mm** long. It is shown in blue in the diagram above.

The building zone is composed of:

- two parts at the table level, along the front side of the table, facing the public,
- one central raised part, along the front side of the table, facing the public,
- one circular raised part located at the exact centre of the table

All building zones are common to both teams. Only constructions whose base is entirely contained in them will be counted in the scoring. More details about building zones can be found in paragraph “*Building areas*” page 11.

Several element dispensers represent the stonemason's workshops. They are detailed in paragraphs “*Column element dispensers*” on page 13 and “*Lintel storage*” on page 13.



---

**Rules 2009**

---

**3.3.1. Tolerances**

The tolerances for playing area construction are **2%** of each dimension for **physical characteristics** and **10%** (of the containing playing area dimension) with respect to **painted markings**.

**3.3.2. Starting zones**

The starting zones are placed in the back corners of the table. Each zone is a **500 mm** square, painted in the colour of the team (red or green). At the beginning of the match, the robots must be placed **fully contained** within these zones. This means that the vertical projection of the robot's convex envelope must fully fit into the starting zone.

No obligation is made for the robots to be in contact with the table borders.

**3.3.3. Borders**

The borders of the table are **70 mm** high (above the table level) and **22 mm** wide.

The front border consists of two parts:

- a low part similar to the three other borders, but made of Plexiglas so that the public can see the robots extracting the elements from the dispensers
- above the front scoring areas, a **250 mm** high Plexiglas plate, allowing the public to see all the constructions made by the robots and which may also be used as a support for building the constructions.

*The exact thickness of the Plexiglas border is not specified, and will be dependant on the available supply in each country. So do not make any assumption related to this point, and do not design your robot in a way which could be impacted by it. No protest will be taken in consideration on this topic by the referees.*

The borders are painted in white (except the Plexiglas, of course).

For compliance to safety rules and in order to prevent laser beams to go outside the table, the Plexiglas plates will be masked from the level of the table up to **30 mm** high. This will be done by opaque black adhesive tape.

**3.3.4. Beacon supports**

Robots can make use of beacons to help in localization, game elements dispensers docking,... These beacons are detailed in section "Beacons" on page 26. If used, the beacons must be placed on dedicated supports.

All supports are **80 mm** square platforms. The platform is covered with Velcro (rough "hook" side).



---

## Rules 2009

---

Two kinds of supports are available :

### Terrain supports

- 6 of them are available
- they are placed **350 mm** above the table level
- They are located at the table angles and in the middle of each of the shorter sides,
- Assignment to the teams is illustrated by the drawing on the right
- They are entirely painted in black

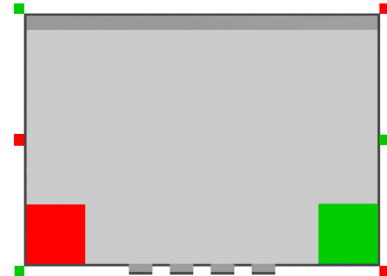

### Dispenser beacon supports

- 4 of them are available
- They are placed on top of the column element dispensers
- They are assigned to the team based on the colour of the column elements contained in the dispenser.
- They can be made of Plexiglas, like the dispensers themselves.

All the dimensions are detailed in the technical drawings.

## 3.4. Building areas

To score points, robots need to build constructions in defined zones of the table. These areas are the only parts of the table where constructions will be scored.

Three building areas are located along the front border (facing the audience) :

- two at table level (labelled **1**)
- one central and raised (labelled **2**)

A cylindrical additional one (labelled **3**), figuring a hill, is located at the centre of the playing area.

---

## Rules 2009

---

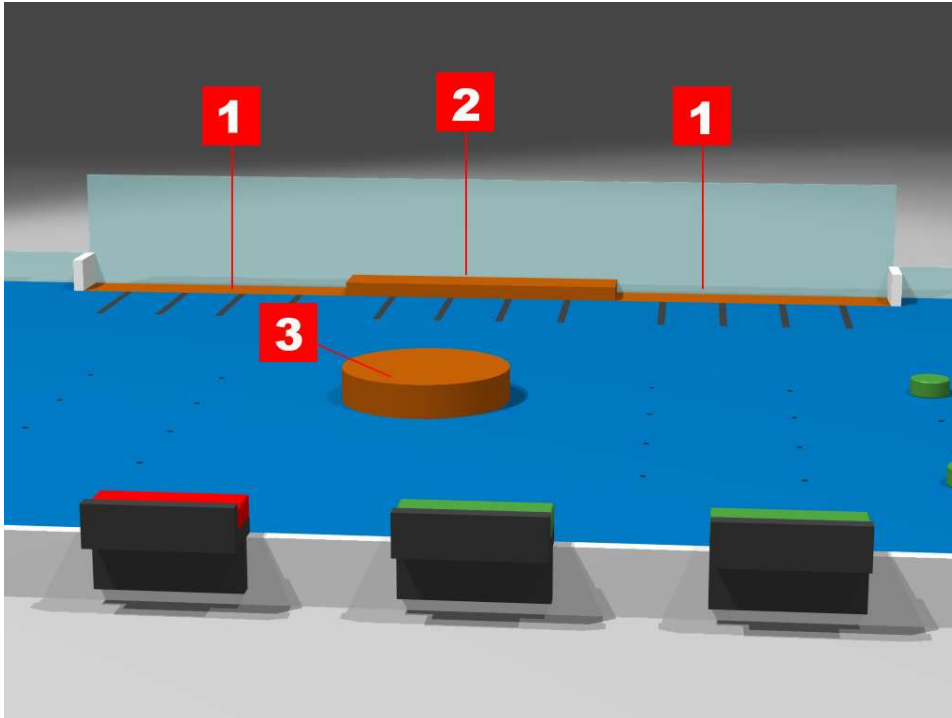

The score of the buildings depends on the zone in which they were built, the score calculations being detailed in paragraph “Scoring” on page 15.

The front scoring zones **1** are terminated by an outside border on their free end, similar to a table border.

Helpers are placed on the ground, indicating positions of the columns properly spaced so that a temple can be built there. They are made of a black line, painted on the ground, perpendicular to the limit of the front building areas.

All detailed dimensions and positions of these zones and the helper lines are indicated in the plans in the technical drawings.

### 3.5. Dispensing zones

The robots may go and get elements for constructions in various dispensing zones.

At the beginning of the match, column elements are distributed on the table and in dispensers as follows:

- **12 column elements** on the table: 6 green and 6 red,
- **20 column elements** in the dispensers (2 x 5 column elements for each colour).

The lintels are located in their own bases.



---

## Rules 2009

---

### 3.5.1. Column element dispensers

There are 4 column element dispensers, placed along all sides of the table.

- each dispenser is filled with elements of the same colour
- each team has 2 dispensers : one at the table front, and one on the short side of the table. Both dispensers are located in the half of the table opposite the team's starting area
- the dispensers on the table front are in fixed positions
- the dispensers on the table sides will be placed in one of two random locations along the table side at the start of the match. They will be placed opposite each other. The two random positions are symmetrical with respect to the middle of the table side.
- the positions of all the dispensers (fixed and random) are indicated in the technical drawings.

They are made so that when one element is withdrawn from the base, another element (if there is any left) comes down and takes its place. Only one element can be taken at a time.

The dispensers are made of a transparent tube. The external face of the tube is tangent to the inner face of the border. The part used to attach the dispenser to the border will be fully contained in the horizontal projection of the tube. In other words, no element of this part of the dispenser will protrude laterally from the tube itself. Detailed dimensions of the dispensers are provided in the technical drawings.

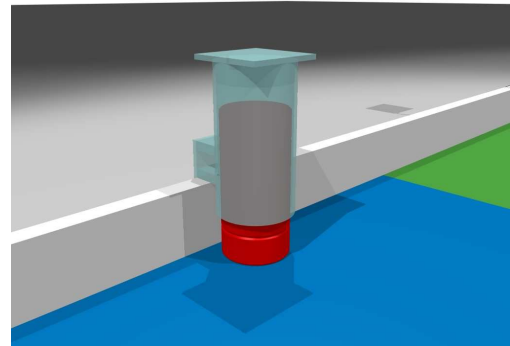

No additional equipment is added to the dispenser, so that the force to be applied to extract the elements is equivalent just to the one to overcome the friction caused by the table surface below, and the elements resting above it. *It is important to consider that the characteristics of the paint may change according to the room temperature, particularly because of the heat from the spotlights above the table.*

As described in paragraph “Beacon supports” on page 10, attached on its top, each dispenser has a beacon support on which the team is allowed to place any beacon conforming to specifications detailed in section “Beacons” on page 26.

### 3.5.2. Lintel storage

Lintel storages are special places from where lintels can be picked. They are distributed along the back side of the table.

- Each storage contains one lintel
- These storages are placed along the back side of the table, outside the table surface
- The lintels' storages of a given colour are placed in the half of the table containing the starting area of the team of the same colour.



---

## Rules 2009

---

Each storage is built so that a gap exists between the top of the table border and the bottom face of the lintel, allowing the insertion of a grasping mechanism.

Lintels are placed in their storage with their back face in contact with the back plate of the base.

In order to ease positioning of the robot, a black line is painted on the ground, perpendicular to the table border, and centred on each of the storages.

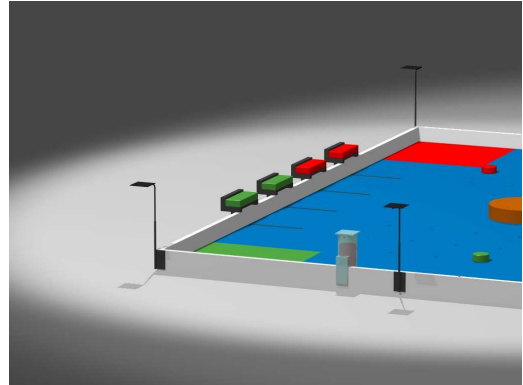

Shape, detailed dimensions and positions of the storages and helper lines are indicated in the technical drawings accompanying this document.

### **3.5.3. Pre-loaded lintel**

The teams are allowed to include one lintel into their robot before the beginning of the match, in addition to the two ones placed in the bases. If the team decides not to do so, this extra lintel stays out of the game.

### **3.5.4. Free elements**

24 locations for column elements are defined on the table, as shown on the diagram here after : **4 fixed** and **20 random** locations.



---

## Rules 2009

---

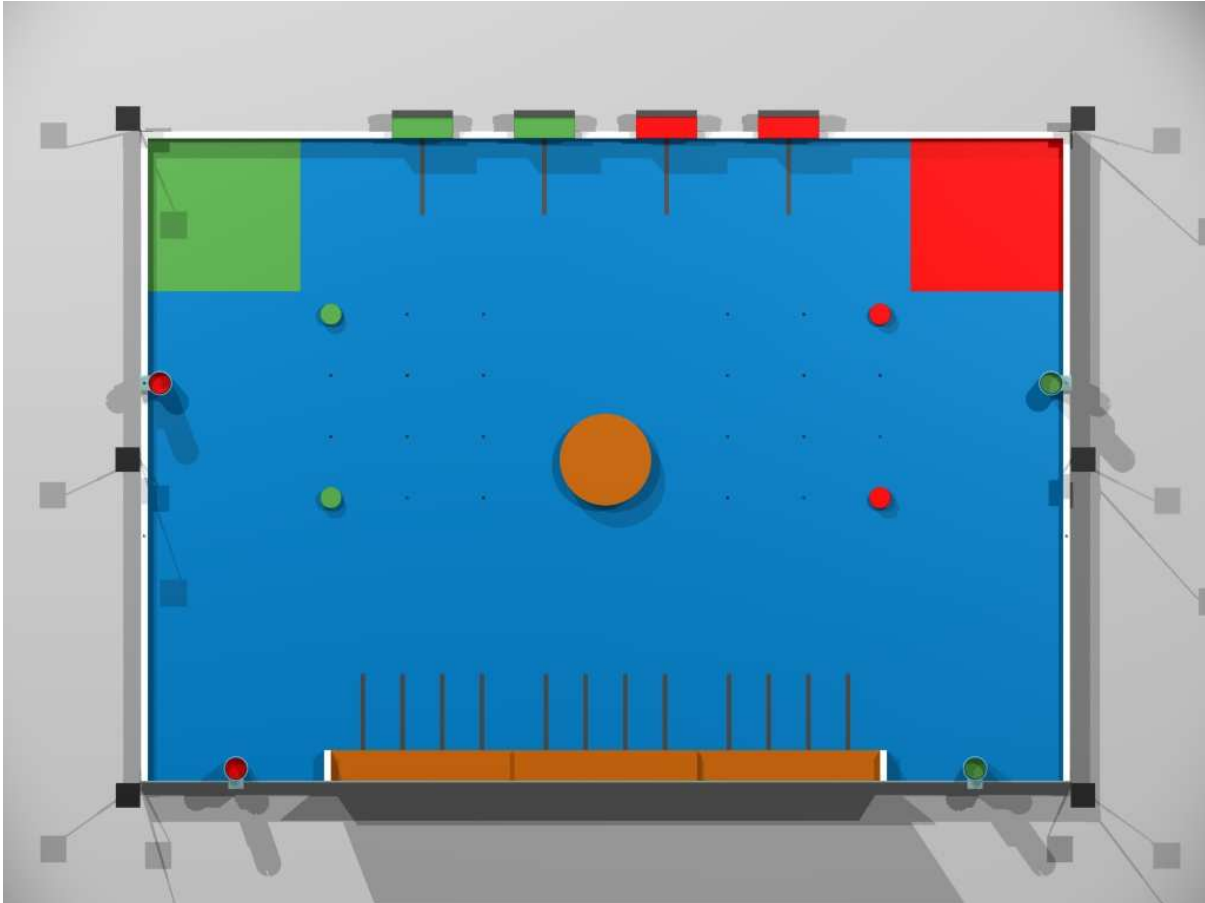

The fixed locations are indicated by elements already in place. The random locations are indicated by the points. All locations in the same half of the table will contain elements of the same colour. Before the match, the referees select randomly the distribution of the remaining 8 elements on the random locations, using a card game defining the possible configurations.

The random locations are symmetrical with respect to the median axe of the table, in order not to favour either of the teams. To limit de number of combinations, these configurations are symmetrical with respect to a line located between the second and the third row.

A facsimile of the cards used for the selection is included in “Appendix B - Random cards” on page 36.

### 3.6. Scoring

Points are always counted once the match is over. The score is calculated from the achieved Game Points plus additional Destruction Compensation and minus any applied Penalties as described below. The team with the higher resulting score is the winner of the match. In qualification rounds additional Match Points are awarded depending on the match result.



---

## Rules 2009

---

The different scoring components are detailed in the following sections.

### 3.6.1. Game points

Only building elements located in the building areas defined in section “*Building areas*” on page 11 are scored. The rule to define a scoring, or valid element is as follows:

- A **column element** laying down (having a vertical axis) and entirely contained in a scoring area is a *valid* element.
- A **column element** laying down (having a vertical axis) supported by **at least one** valid element is a *valid* element as well.
- A **lintel** laying down flat (on its biggest face) supported by **at least two** valid elements is a *valid* element as well.

The score is then awarded to all **valid base** elements as follows <sup>1</sup>:

- A valid base **column element** scores a number of points equal to its level with respect to the table. The calculation of column element score thus starts:
  - from 1 for building zone **1**,
  - from 2 for building zones **2** (as shown in the example below), or
  - from 3 for the building zone **3**.
- A valid **lintel** earns a number of points equivalent to **3 times its level**.

An example of the score calculation is shown in the figure below. In this case, the building was made in the building zone **2**:

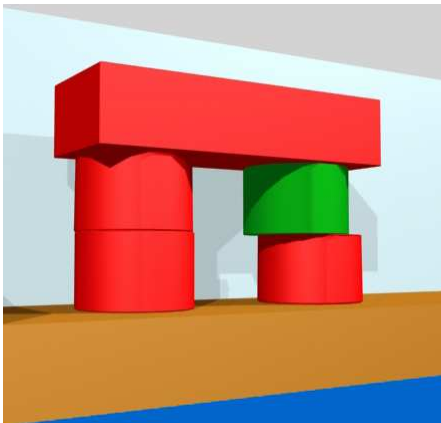

#### Red team

Left column:  $2 + 3 = 5$   
right column : 2  
lintel:  $4 * 3 = 12$

Total : 19 points

#### Green team

Right column : 3

Total : 3 points

---

<sup>1</sup> Refer to paragraph “*Building areas*” on page 11 for the definition of the numbering of the building areas used in the following text





---

**Rules 2009**

---

**3.6.2. Destruction compensation**

The focus this year being the building actions, any strategy based on the destruction of the already made buildings will be sanctioned with a penalty, as described in paragraph “Penalties” below.

A team is not even allowed to dismantle an existing construction piece by piece. Note that every time a construction is damaged voluntarily, penalties may be issued.

Moreover, and in order to reduce the damage to the opponent's score, the opponent will be credited points whenever a **construction involving his elements is damaged**. The number of points credited depends on the zone containing the original construction:

- 10 points for every individual **damaged column** (regardless to the number of contained column elements) or knocked-down **lintel** originally contained in the building zone **1**,
- 15 points for building zones **2**,
- 20 points for the building zone **3**.

**3.6.3. Penalties**

Every action that is not fully in line with the rules or the spirit of the competition, namely some of the points noted in paragraph “Penalty points” on page 29 will be penalized.

A **penalty** consists of subtracting **3 points** from the total score achieved in the current match. Note that more than one penalty can be issued at a time.



*It must be noted that **negatives scores are possible** if penalties exceed the number of points scored during the match.*

**3.6.4. Match points**

A **preliminary total** for the match is calculated by adding the Game Points and the Destruction Compensation and subtracting the Penalties as described above.

Match points will then be added to these points, based on the following rules:

- 10 points for a victory,
- 6 points for a draw,
- 2 points for a defeat,
- 0 points for a scratch.

A score of 0/0 (or below) is considered as a double defeat. Thus, each team gets only 2 match points.



*A **null score against a negative score** (because of penalties) does not award a victory. The team which scored a null score is considered as a defeat and as a consequence is awarded only 2 points for the match.*



## 4. The robots

### 4.1. General conditions

Each team is allowed to compete with only one robot.

They are not allowed to enter several robots that are **different** (*for example, presenting a different robot according to the colour attributed to the team for each match*).

Every structural modification during the competition implies another approval phase.

The robot is a fully autonomous machine. It shall carry its own power source, actuators and control system.

The robot is only allowed to communicate with the localization beacons (see section "Beacons" on page 26).

All parts of the robot must remain physically connected - therefore the robot cannot leave parts of itself on the playing area.

### 4.2. Robot dimensions

Robot can have deployable extensions, their deployment is allowed after the match start signal only.

The perimeter of the robots is defined as the convex envelope which fits the vertical projection of the robot on the ground.

The perimeter of the robot, in its starting configuration shall not exceed **1200 mm**. The perimeter of the robot in a fully deployed configuration shall not exceed **1400 mm** at any time during the match. The playing elements controlled by the robot during the game are not included in these dimension limits.

The height of the robot shall not exceed **350 mm**, excluding the beacon supporting mast, potential sensor equipment within the beacon support mast's envelope and the pressing part of the emergency stop button.

Teams are warned that though some tolerance is allowed with respect to the maximum height for the emergency stop button, this must not represent any form of annoyance for opponent beacon systems.

All other systems, including mandatory systems, must be contained within the volume specified above.

***The limitation in height includes all the carried elements. This restriction is set in order for these objects not to interfere with the opponent robot communicating with its beacons.***

---

## Rules 2009

---

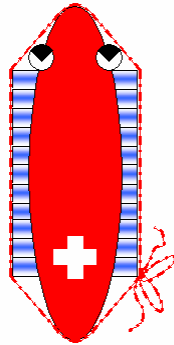

--- <= 1200 mm

Starting configuration

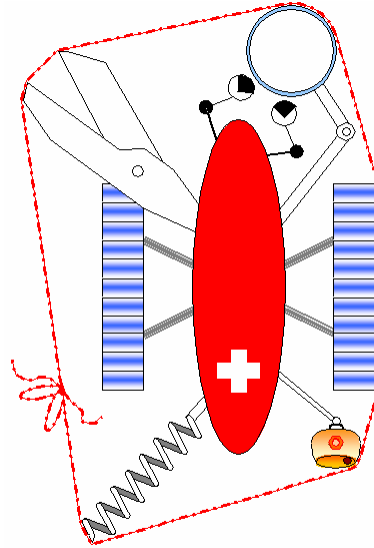

--- <= 1400 mm

Deployed configuration



**Important notice :** Since it has been observed that every year some robots are slightly above the allowed dimensions because designed too close to the limits, teams are strongly advised to keep some safety margin, and stay several millimetres under the above mentioned limits, so that no “bad surprises” occur during approval.

### 4.3. Visibility

The refereeing committee encourages the teams to make the interior parts of their robot visible.

Two areas of 100 mm x 70 mm must be available on the robot for the placement of stickers (number of the team and logos of the sponsors of the event, printed by the organizer). The areas should be placed on two different sides of the robot.

### 4.4. Limitations

The aim is to share a friendly time and play as many matches as possible. Therefore, any action not directly in line with the match spirit as laid out in this document or harmful for match development is not welcome and may be penalised.

#### 4.4.1. Fair-play

In the spirit of fair-play, a robot's strategy may not be:

- to block the opponent robot's access to an element or to an area of the playing field,



---

## Rules 2009

---

- to use objects of colours or shapes when designing the robot in order to confuse the opponent. None of the colours mentioned in these rules for the playing field elements or elements of play may be used on the robot,
- the robot causing intentional damage to the opponent robot, the playing area, or any of the playing field elements,
- to use a fixing system to attach the robot to the field (e.g. suction cups). At any time during the match, the effort required to lift the robot must not exceed its own weight,
- to use systems designed to make the table vibrate,
- to keep the playing elements of the opposing team or more generally, to prevent the opponent's robot from accessing its own playing elements.

### 4.4.2. *Limitation of controlled game elements*

The robots must scrupulously adhere to the limitations detailed in “Limitation of controlled elements” on page 20 if one is applicable. Failure to do so may result in severe penalization and even a re-approval may be requested if the violation is performed repeatedly.

### 4.4.3. *Usage of fans*

Usage of fans to move the elements of play on the table by blowing is not allowed. The reason for this rule is that no such system is able to ensure the limitation of controlled game elements noted above is fulfilled.

The usage of a vacuum-based system to pick up and manipulate the playing elements is allowed.

## 4.5. Mandatory equipments

All robots must include the following systems, or they will not be approved for competition.

### 4.5.1. *Starting cord*

The Robot must include a starting device, easily accessible on the robot. It shall be triggered by pulling a cord **at least 500 mm long**. This cord shall not remain attached to the robot after it has been started. Any other system to start the robot (remote control, toggle switch directly activated by hand, etc...) will not be approved.

### 4.5.2. *Emergency stop button*

The robot must include an emergency off button, with a diameter of at least 20 mm and painted in red. It shall be placed on the top of the robot, in a conspicuous position and in a zone that is not dangerous and that is immediately accessible to the referee at any time during the match. The stop button must be activated by a simple downwards pushing motion.

Pressing the emergency button must result in the immediate shut down of all of the robot's actuators, leaving them limp (neither actively braked nor energized). This includes all drive motors, actuator motors, internal systems and all other moving parts of the robot.



---

## Rules 2009

---

The emergency stop button must also immediately shut down all laser devices used in the robot.

### 4.5.3. Automatic shut down

Each robot shall accommodate a system which shall stop the robot automatically at the end of the 90 second match duration. "Stop" implies complete shut down of all actuation including internal devices. Robots moving after the end of the match will be penalized or disqualified.

### 4.5.4. Obstacle avoidance system

Teams are required to equip their robots with an obstacle avoidance system. The system is intended to prevent collisions and damages between robots during a match.

The robot must be able to avoid at least a fake robot, as described in paragraph "Practical trials" on page 31.

### 4.5.5. Robot localization beacon support

It is strongly recommended to design the robot with a support to accommodate a localization beacon prepared by the opponent team.

If desired, the support can be designed to be detachable, so that it is only used if the opponent needs it. In this case the design must allow the support to be quickly attached before the match.

Finally, a team may choose not to include a beacon support. In this case, if the opponent provides a beacon and wants to use it during the match, the team will be disqualified for not having the support.

The beacon support shall at all times comply with the following constraints:

- It is a **80x80 mm** square surface, located **430 mm above the floor level**. The structure supporting this platform must stay within the vertical projection of this platform. This mast cannot host any parts of the robot other than sensors. The mast shall be robust and rigid enough to support the opponent's beacon in a stable fashion. The team is responsible for the robustness of its mast.
- The platform surface of the support shall be fully covered with Velcro™ (rough "hook" side)
- The support shall be located close to the horizontal centre of the robot. In the robot's not deployed configuration, the distance between the support and the maximum robot extension on one side shall not be less than 50% of the equivalent distance on the opposite side.

### 4.5.6. Technical poster

Each team is required to provide a technical poster during the approval phase.

This poster should present information related to the design of the robot (drawings, technical references, design specifications, etc...). It should be at least DIN A1 in size, and ideally should be printed. The poster is intended to promote exchange and communication between teams.



---

## Rules 2009

---

Effort should be made to make the poster understandable to a non-technical audience. Ideally the poster should include pictures and diagrams to help explain the concepts.

The poster must also include:

- the name of the team,
- the names of the team members,
- the nationality of the team.

This poster will be displayed in the team's pit. An English version of the poster must be supplied. Optionally, the team can provide other language versions as well.

The poster shall be supplied to the Eurobot association in **PDF Format**. The chosen resolution of the PDF must guarantee that all texts on the poster will remain readable. If possible, the file size of the PDF should remain below **25 MB**. The PDF Version of the poster may be sent to Eurobot beforehand via your National Organisation Committee, or may be provided on CD-ROM or USB key at the competition, during the approval for your robot.

In general Eurobot encourages the teams to communicate about their projects, for example by posting in the Eurobot forums.

### 4.6. Energy sources

Allowed energy sources include springs, pressurised gas, solar cells (note that the competition will be held indoors) and most types of commercially available batteries and power cells,

Prohibited energy sources include all types of combustion engines, rocket engines, hydrogen fuel cells, any other type of burning or pyrotechnics, living beings and radioactive energy sources of all types.

If in doubt about your unusual energy source, ask the refereeing committee ahead of time.

With respect to batteries, use only models with solid electrolyte in order to prevent any problem with corrosive liquids.

It is strongly recommended for teams to possess several battery sets and to design for easy access in the robot for their replacement. The teams are reminded to have spare, fully-charged batteries available at all times.

Teams are required to be capable of playing two matches in succession. Note that this includes the necessary “set-up time”, when the robot is powered on and waiting to start, but the match has not yet begun.

### 4.7. Control systems

The teams may use any kind of robot control system (analogue, microprocessors, micro-controllers, computers, programmable logic, etc.).

Those systems must be fully integrated into the robot.

The control system must permit the robot to play a match as either colour. The colour of each team will be decided just prior to the match.



---

## Rules 2009

---

The control system must permit the robot to pass the approval phase.

### 4.8. Safety

One of the design goals for your robot should be to develop systems that are safe for people, both during the competition and during the construction and experimentation phase of your project. This is also why you must ensure that your systems comply with applicable regulations for technical devices.

The robots must not have any protruding or sharp parts that may be able to inflict injury while casually handling the robot. The use of liquid products, corrosive products, pyrotechnic materials or living beings in the robot is also forbidden. Each of these points will be checked during the approval phase of the competition, before the robot is allowed to participate to matches.

As a general rule, any device or system considered as potentially dangerous by the referees will be rejected, and must be removed from the robot prior to competition, or result in the team's disqualification.

All the systems on the robots shall respect existing national and European laws and specifications. Specifically, the systems used shall comply with legal safety regulations and must not endanger the participants or the public both during matches and backstage.

Hereafter are listed some safety regulations. This list is not exhaustive - the referees' decisions are final on what is dangerous, and what is not.

**Teams not complying to these rules (by providing incorrect documentation for instance) will be held responsible in front of the justice in case of any damage resulting from their system.**

#### 4.8.1. On-board voltage

All robots must comply with the legal standards concerning "low voltage". Therefore, the internal voltage of the robots **shall not exceed 48 V**.

Internal voltage is defined as the electrical potential between any two parts of the robot, with or without its casing in place. This includes components insulated by the teams themselves, using adhesive tape, thermo-shrinking tubing, or any similar non industrial process.

It is permitted that potentials higher than 48V exist, but only inside sealed commercial devices (such as lasers or LCD display back lighting) and only if these devices have been left unmodified, and themselves comply to national and European regulations.

#### 4.8.2. Lasers

Only considerations based on laser class definition (in the "EN 60825-1:2007, Edition 2 - Safety of laser products - Part 1: Equipment classification and requirements" standard) will be taken in account. Teams using a laser will have to provide the classification notice of the equipment, or the data sheet of the laser component. Not being able to provide such documents will prevent the robot to be approved as is.





## Rules 2009

Based on the classification, it is allowed to use lasers of Class 1, 1M, 2, 2M. All other classes (3R, 3B and 4) are strictly forbidden.



**Additional constraints for robots competing in France (all French Cup robots, European ones qualified for the Eurobot finale).**

*Lasers class 2 and 2M are accepted if and only if the laser beam is never projected outside the table. Since the front Plexiglas border is masked from 0 to 30 mm high, this means that beams of such laser device must be constrained in this vertical range.*

For safety reasons, laser components salvaged from CD/DVD readers or writers are not allowed. Even if these consumer devices are classified as class 1 laser devices, this classification is valid only if the device is kept unmodified and with its casing in place. Lasers components included in such devices can be class 3 because of its wavelength and/or energy used. Therefore it is not permitted to use these components in the competition.

**CAUTION : disassembling such products and have them operate without their casing can be extremely harmful (this is indicated by the stickers that should be present on the casing of the device)**

Robots using class 2 and 2M lasers must show on their casing a laser caution label according to the official laser products users guide (IEC TR 60825-14: 2004 Safety of laser products. A user's guide), such as the following one :

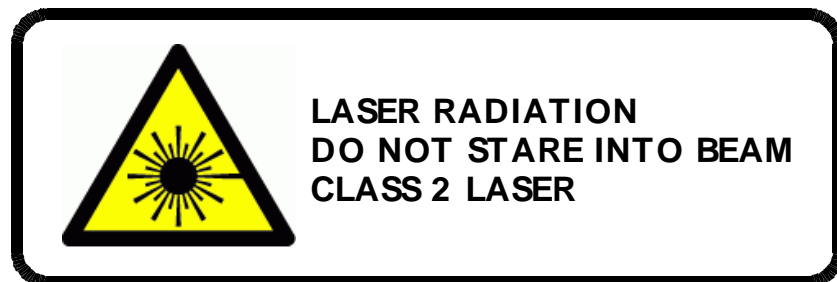

### 4.8.3. Powerful lights

When high intensity light sources are used, be aware that the light intensity can be dangerous for the human eye. Note that some commercially available high power LED devices can exceed this limit.

### 4.8.4. Compressed air systems



**This paragraph applies to robots competing in France (all French Cup robots, European ones qualified for the Eurobot finale).**

All pressure systems must comply with the "Conseil Général des Mines" Decree 63 of January 18, 1943 and Ministerial Order of July 25, 1943 :

- Maximum service pressure : 4 bars
- Maximum pressure x Tank volume <= 80 bar.liter

Further information can be found on <http://www.industrie.gouv.fr/sdsi/>





Eurobot 2009

# Temples of Atlantis



---

## Rules 2009

---

### 4.9. Other systems

All other systems are, in principle, allowed, provided of course they comply with the rules outlined above. Use your imagination !

For example, in order to encourage innovation and provide an interesting show for the public and media it is suggested to implement sound or emotive behaviours into your robot.

## 5. Beacons

### 5.1. General comments

Beacons are not allowed to obstruct the opposing robot. If there is any doubt that they may deliberately disturb the development of the match, the team will not be allowed to use them.

The beacon supports are placed in the locations detailed in paragraph “*Beacon supports*” on page 10. They are placed on the outside of the table.

The beacons’ undersides are covered with Velcro (soft “loop” side) as a way to fasten them on their assigned support.

The beacons (robot localization or fixed ones) shall remain on their support throughout the matches.

The use of beacons is optional.

All safety standards applicable to robots are also applicable to the beacons.

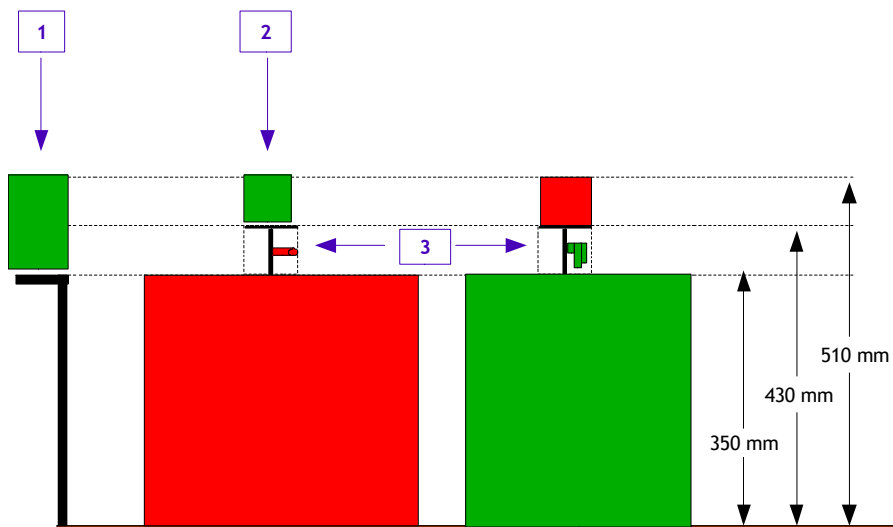

**Legend :**

- 1 : Fixed beacon (80x80x160 mm)
- 2 : Robot localisation beacons (80x80x80 mm)
- 3 : Mast (area for sensors only)



---

**Rules 2009**

---

## 5.2. Robot localization beacon

One localization beacon can be fitted onto the other robot, in order to locate it. This beacon will be fitted on the beacon support provided for this purpose by the opponent robot.

Only one localization beacon is allowed per team.

The maximum size for a robot localization beacon is a **cube with 80 mm sides**.

The elements used for the beacon design shall be useful. If necessary, the referee may request that the team opens its beacon casing for inspection and verification.

The robot localization beacon top shall be covered with Velcro (rough “hook” side) able to support the flag module identifying the robot's allocated colour.

## 5.3. Fixed beacons

Each team can put a beacon on any of the fixed beacon supports placed around the playing area. See “Beacon supports” on page 10 for details.

The fixed beacons must remain within a square base of **80x80 mm** and can be up to **160 mm high**.

The fixed beacons can be linked together by a wire. This optional wire must not disturb the development of the match and the team must be able to install it during the 3 minutes for match preparation without disturbing the opponent team.

Temporary wire connection between the beacon and the robot is allowed during the preparation phase before the match, but on the definite condition that it doesn't disturb the preparation of the opposing team. In case of a justified complaint from the opponent, the team will have to cease using this equipment.



*Given that the 3 minutes time period allowed for the preparation is very short, and that any team not respecting it will be penalised, we strongly advise against the use of such equipment.*

## 5.4. Communication signals

In order to avoid interference between the teams, it is recommended to encode the communication signals. We strongly recommend that teams using infra-red devices take into account the strong ambient light used during the competition. Moreover, this illumination may vary over time and location during the competition.

We also mention that the competition staff uses high frequency radio devices during the contest.

No complaint regarding interference problems will be taken into account. The beacons must be able to cope with the conditions that may change depending on the moment and their location during the contest.



## 6. Match timeline

---

### 6.1. Robot identification

For each match, the robots are allocated a team colour marker, built as a small flag module in red or green. The marker is to help the public recognize which robot belongs to which team.

The flag module mass is negligible. It is placed directly on the robot beacon support, or directly on the robot. If the robot does not provide a beacon support, it must provide a **80x80mm square** surface covered with Velcro (rough “hook” side) at the top of the robot to place the flag marker on.

### 6.2. Starting procedure

- A colour (red or green) and therefore a side of the playing area is allocated to the team before each match.
- Only two members from each team are allowed to access to the stage area for robot preparation.
- Both teams have 3 minutes to put their robot on the starting position, to prepare it and to install all beacons.
- The robots are placed on the table, entirely within their starting areas.
- After the **3 minutes** preparation time, no more intervention or transmission of external information to the robot is allowed.
- When both teams and the referees indicate they are ready, the referee will determine the random positions for the playing elements to be placed on the table. This is done by drawing from a set of cards. These cards are provided in the Appendix of this document (“*Appendix B - Random cards*” on page 36). During this procedure, the teams are not allowed to touch their robot nor communicate with it.
- The referee asks the participants if they have any remark about the placement of all the game elements. No objection regarding the placement will be accepted after this point.
- At the start signal given by the referee, the robot is activated by one of the team members using the starting cord. The robot shall then run on its own in a fully autonomous way.

Any team which does not scrupulously follow this starting procedure is charged with a false start. A new start shall be given with a new random layout for the game elements. Penalties may be applied for causing the false start.



---

## Rules 2009

---

### 6.3. Match sequence

Robots have **90 seconds** to score as many points as possible. This must be accomplished in complete autonomy.

The team members are not allowed, in any way, to touch the robots, the playing area or any of the fixed game elements during a match. **Any such action made without the referees consent will lead to disqualification for the current match. The team will then lose all the points it may have scored during the match.**

If the robot leaves the playing area it may not be put back in. The match is not replayed and the other robot is allowed to finish the match normally.

A robot that deliberately pushes its opponent out of the playing area is disqualified.

At the end of the match, the robots must stop (shut down of all actuation) by themselves. If the robot does not shut down by itself, a referee will push the emergency stop button to stop the robot.

The referees will count the points without touching the robots. Then they will announce the score.

The team members are allowed to touch the robots and leave the game only with the explicit consent of the referees after common agreement on the score. They must ensure that no element of play remains inside the robot.

### 6.4. Calculation of the score

#### 6.4.1. Game points

Game Points (see page 16) are awarded at the end of the match for the game actions connected to the playing elements.

#### 6.4.2. Penalty points

A penalty results in the removal of points from the score of the team at the end of the match. Any action not compatible with the spirit of the rules may be penalized by the referees. For example, the referees may assign penalties in the following cases:

- When a robot violently collides with its opponent.
- When a robot is considered dangerous for the table, the audience or its opponent.
- When a robot deliberately prevents its opponent to access a game element.
- If a robot's shut-down system fails to work.
- If a robot intentionally or systematically damages the buildings (temples and columns).
- If a robot keeps the building elements the opponent's team.
- If the robot puts playing elements of the opponent's team off the table.



---

## Rules 2009

---

- Whose robot shows a deployment or an action that has not been previously approved by the referees, or any deliberate action not in line with the rules.

Additional penalties can be applied if the referees consider this justified. For instance, if a team has been warned about some negative point during a match, and the same point is noticed during a subsequent match, this will turn into a penalty. The electronic scoring system used for the competition sports a feature to record such warnings, so that the referees can know about past problems with the teams and take them in account accordingly.

Multiple penalties can be applied for one offence, if the referee feels the offence justifies it.

### 6.4.3. Match points

Additional points are awarded in the qualification rounds to the teams accordingly to the result of a match. The system of bonus points is described in paragraph “Match points” on page 17.

### 6.4.4. Scratch and match disqualification

The team is declared scratched (i.e. disqualified from the current match) when some of the following conditions occur:

- it does not come on time to the backstage waiting room for matches;
- it takes more than 3 minutes to get ready on the playing area;
- its robot has not completely left its start area during a match;
- its robot doesn't have a mobile beacon support, when its opponent requests and requires one.

In case of a scratch, no points are given to the team (whether positive or negative).

### 6.4.5. Competition disqualification

The referees may disqualify a team for the competition:

- When the robot makes the same penalized actions systematically
- For unacceptable behaviour
- Failure to comply with safety regulations



## 7. Competition phases

---

### 7.1. Approval phase

A robot must be approved before being allowed to participate in the tournament. For logistical reasons, and reasons of fairness, there is a deadline for approval. All teams must approve their robots before this deadline. Robots that are not approved will not be allowed to participate in the tournament.

#### 7.1.1. *Physical examination and team interview*

The referee examines the robot and interviews the team to check the following:

- That the robot complies with the rules (the robot should be capable of demonstrating all of its possible actions and deployment configurations to help verification).
- That the team provides a required technical documentation of components (e.g. lasers).
- That the team provides a technical poster.
- That the team understands the rules and the spirit of the tournament.
- That the emergency stop button works, and all actuators are shut down when it is pressed.
- The organizer's logo (if required) is placed on the robot so it is visible by the public.

#### 7.1.2. *Practical trials*

In addition, the robot must pass the following tests:

1. That under match conditions, without opponent:
  - The robot is capable of leaving the start area
  - The robot is able to win a match without the opponent
  - The robot's shut down system works properly

2. A test that the robot's obstacle avoidance system works.

The system should be able to successfully avoid a static dummy obstacle, put in the path of the robot. This obstacle is a fake robot made of a 300 mm high and 200 mm diameter cylinder, weighting between 2kg and 3kg. This fake robot sports a beacon platform, so that it is possible to place a beacon on it. The robot must avoid the obstacle, demonstrating to the referees in a convincing manner that it properly takes the obstacle in account.

3. A test that the Limitation of Controlled Elements (see page 8) is guaranteed by the robot's systems. This test is only conducted if it is not evident that the limitation is physically ensured by the structure of the robot.



---

## Rules 2009

---

4. For competitions held in France, in case of class II lasers (be it in the robot or in the beacons) the laser system is tested to ensure that the spot is never projected outside the table.

### **7.1.3. Modifications after approval**

It is mandatory to keep referees informed of any major modifications (functionality, size, etc.) performed after the robot's approval. The referees will check the modifications and re-approve the robot.

Actions used during the match which were not demonstrated during the approval process can lead to penalties or disqualification.

Referees can require a robot to subject itself to another approval process at any time during the competition, if in doubt about its conformance to the rules.

## **7.2. Qualification rounds**

The format of the national competitions may differ from the mode described below. Eurobot encourages the national organizing committees to plan their national tournaments to allow the teams to play many matches. The more matches, the more fun, and the clearer the results.

The Eurobot organization will try to organize at least five matches for each team during the qualification round. The results of the qualification rounds decide which teams go to the final round.

When the qualification rounds are over, the teams are sorted using their cumulative qualification point count. The teams that have the same points count are sorted by comparing the points accumulated during each match without adding the bonus points for match result.

In case of ties, the organisers may request the teams to play extra matches. Pairs of teams competing for the same rank will be randomly drawn, and resulting matches will be played on a knock-out basis. In case of odd number of teams, an additional random match will be played, on the same basis.

## **7.3. Final round**

At Eurobot, the first 16 teams from the qualifying phase are selected for the final round. In a national competition the final round may be smaller, depending on the number of registered teams.

The matches for the final round are organised as shown in the diagram here after.





## Rules 2009

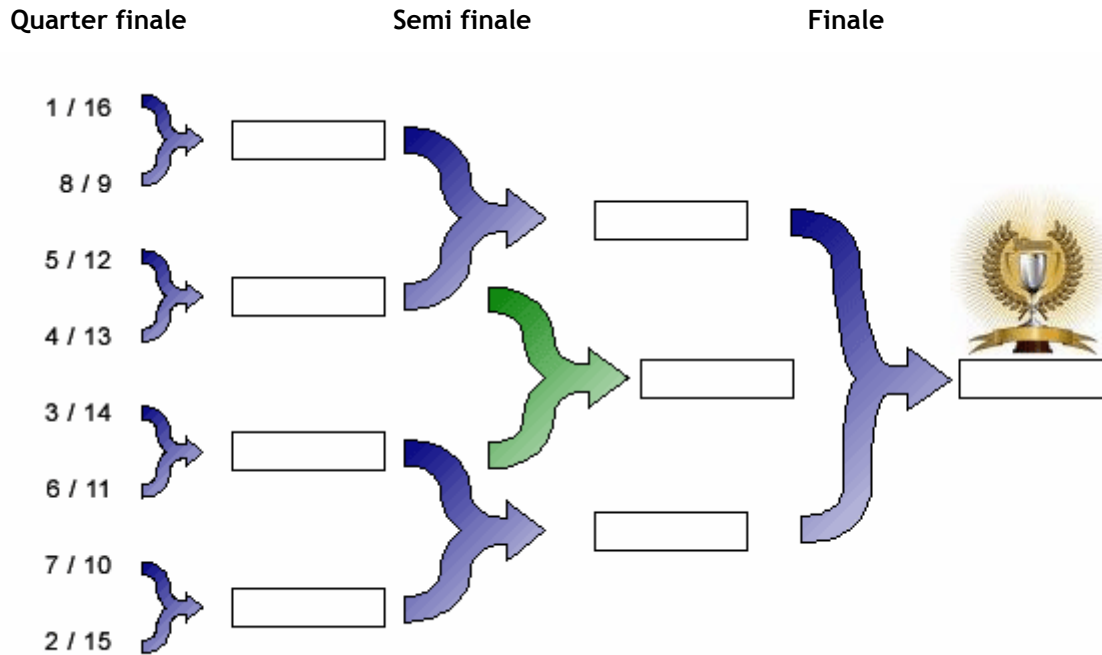

### 3<sup>rd</sup> rank finale

During the final phase, matches are on a knock-out basis.

In the event of a double defeat, a draw or a double disqualification the match is replayed immediately. If this second match is also a double defeat, a draw or a double disqualification, the winner will be determined by the position at the end of the qualification rounds.

The final match is played in **two winning sets**.



## 8. Appendix A - Playing area and elements specifications

The following section provides all the details necessary for playing area construction.

### 8.1. Tolerances

The organisers are committed to build the playing area to the highest degree of accuracy. But they do allow for the following fabrication tolerances:

- 2% with respect to the playing field construction,
- 5% with respect to the playing element construction,
- 10% with respect to painted markings.

No complaints related to fabrication variations within the above tolerances will be accepted. The teams are warned that the paint finish of the table may vary from one playing area to another and may degrade during the competition.

If problems with the rules are discovered, the definition of the field and game components may be modified over the course of the year. We strongly advise participating teams to regularly consult our web site <http://www.eurobot.org/> in the 'FAQ' section for potential amendments and to follow the discussion and the information on the forum <http://www.planete-sciences.org/forum>.

#### **Important notes:**

*Be aware that the flatness of the table is also subject to some variation. While some tables are made of very stiff materials, and perfectly flat, some are softer and may have some degree of warping. The tables may also be made from two or more sections, resulting in a small ridge at some locations on the table surface. For these reasons it is urgently recommended to allow enough flexibility in the robot's drive system, and the robot's clearance to accommodate such variations.*

*Above tolerances apply to the playing field and other components of the game only. They do not apply to robots and localization beacons prepared by the participating teams, which are required to respect the limitations described in this document, without tolerances.*

### 8.2. Technical drawings of the table and the playing elements

Because of their size, the detailed technical drawings with dimensions are gathered in "Appendix C - Technical drawings" on page 39.



---

## Rules 2009

---

### 8.3. References of the paints

Element	Colour	Type of paint	Reference
Playing area	Sky blue	Acrylic, matte	RAL 5015
Building area	Chocolate brown	Acrylic, matte	RAL 8017
Green starting zone	Yellow green	Acrylic, matte	RAL 6018
Red starting zone	Traffic red	Acrylic, matte	RAL 3020

## 9. Appendix B - Random cards

The configuration cards deck is made of two parts :

- 10 cards for the random column elements placement on the ground
- 2 cards for the moveable vertical dispensers placement

A facsimile of these cards is included hereafter for convenience.

### Column elements placement

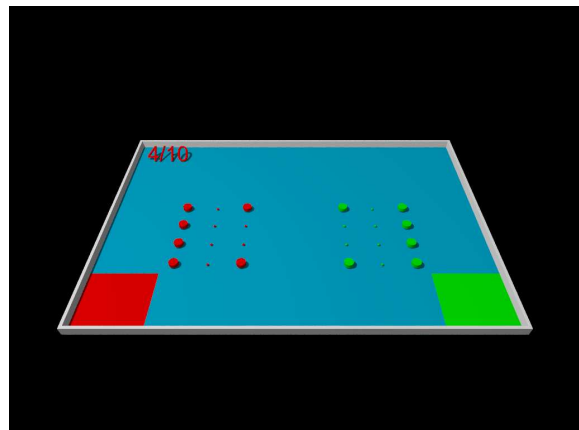
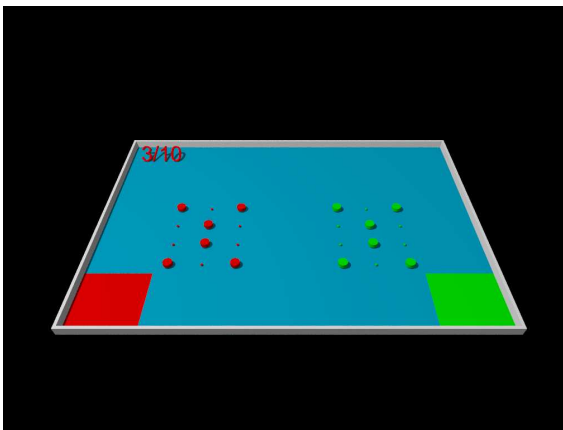
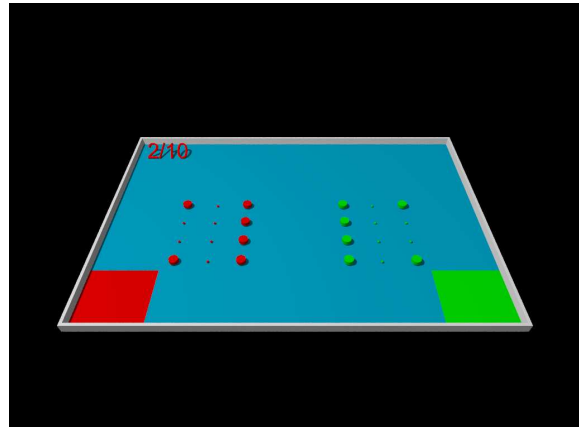
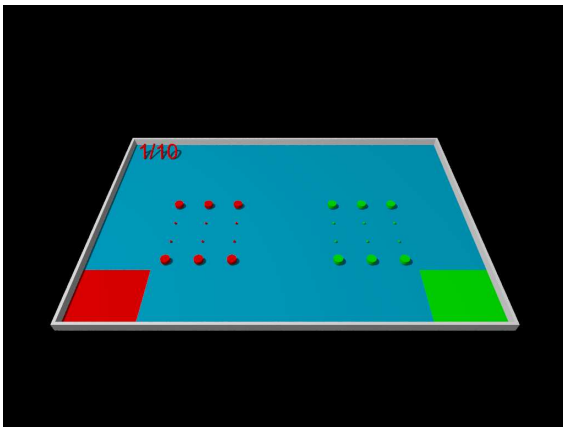



Eurobot 2009

# Temples of Atlantis



## Rules 2009

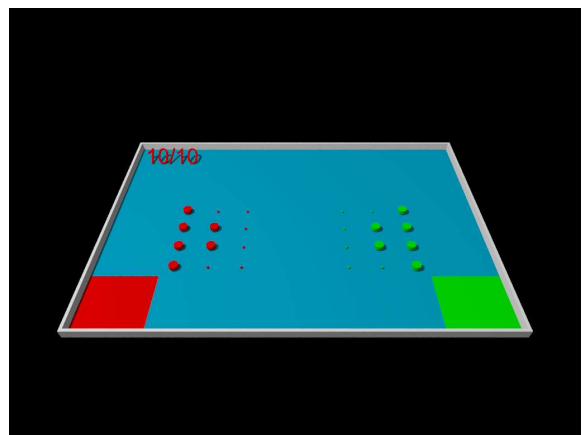
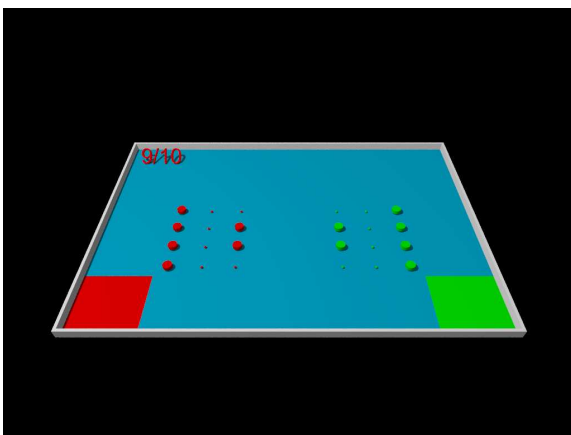
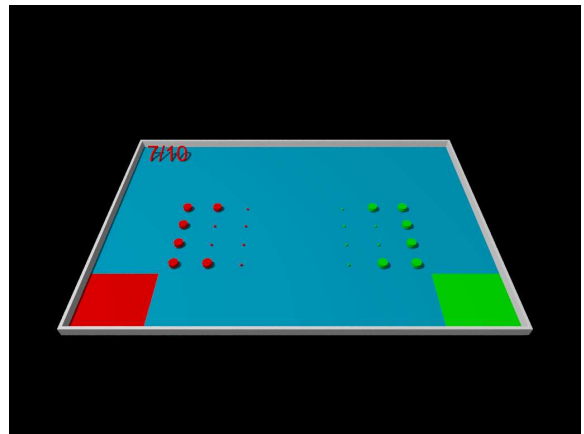
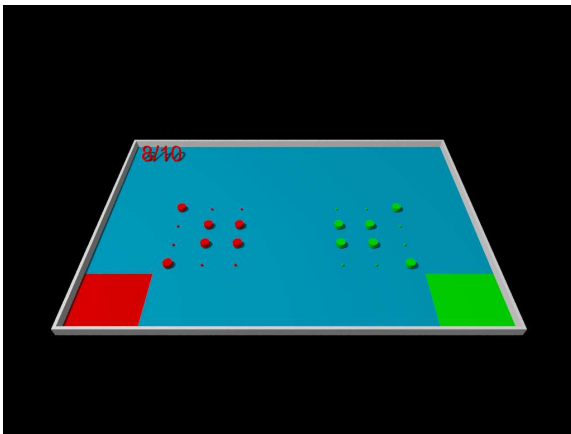
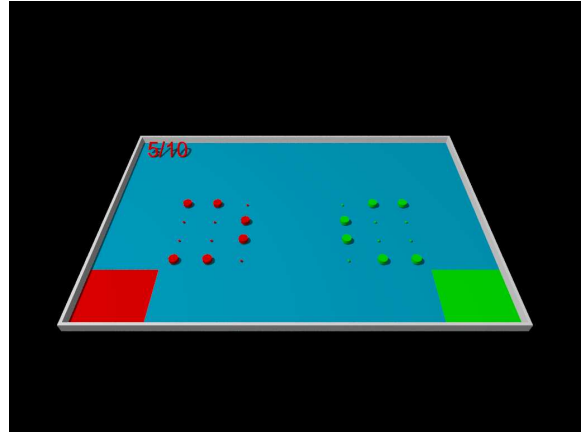
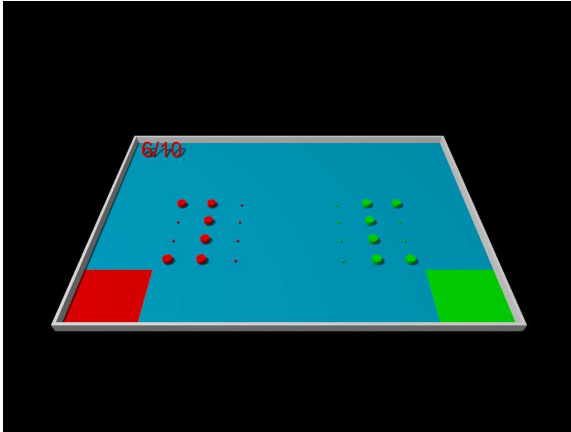



Eurobot 2009

# Temples of Atlantis



---

## Rules 2009

---

### Dispensers placement

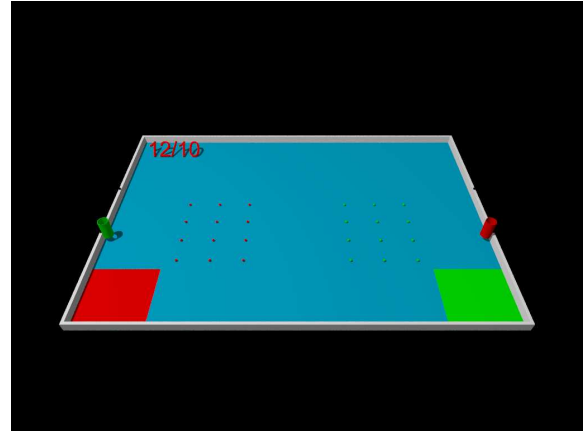
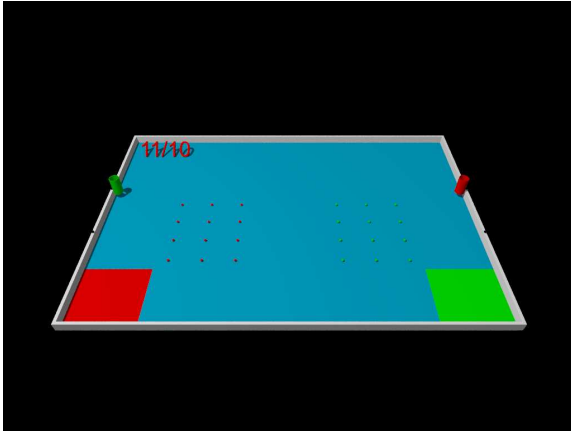



Eurobot 2009

# Temples of Atlantis



---

Rules 2009

---

## 10. Appendix C - Technical drawings

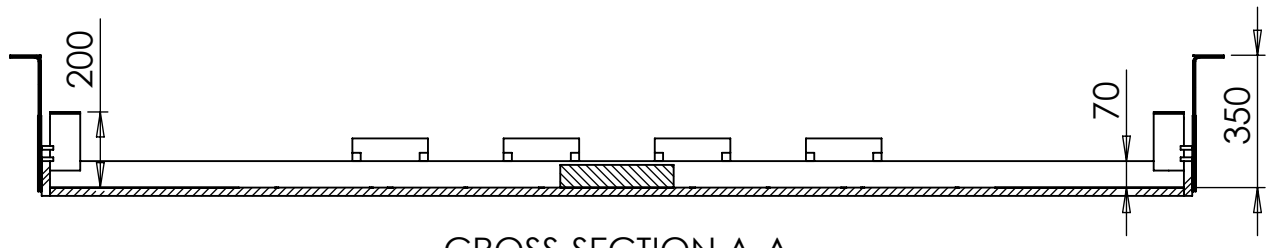

CROSS-SECTION A-A

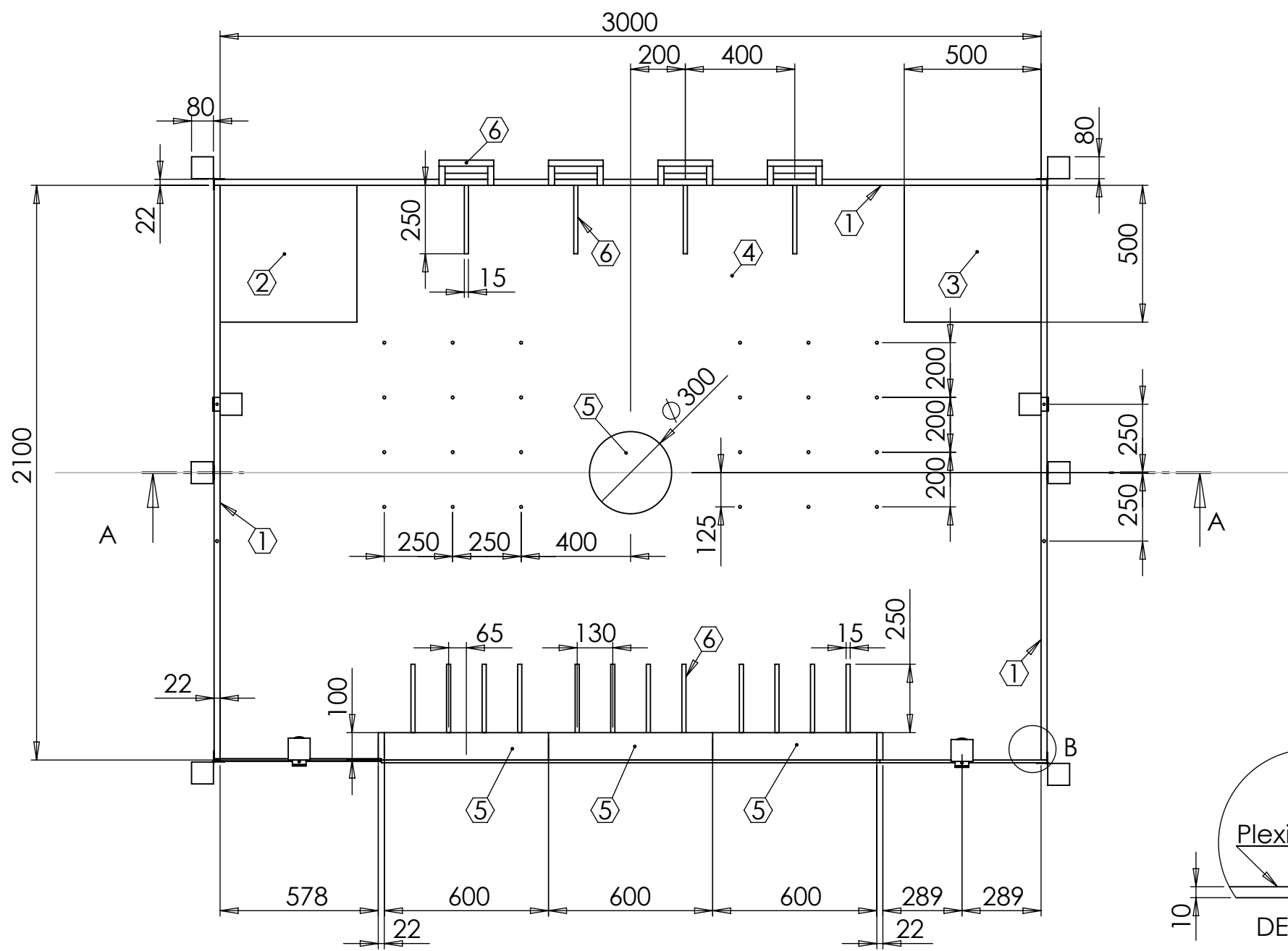
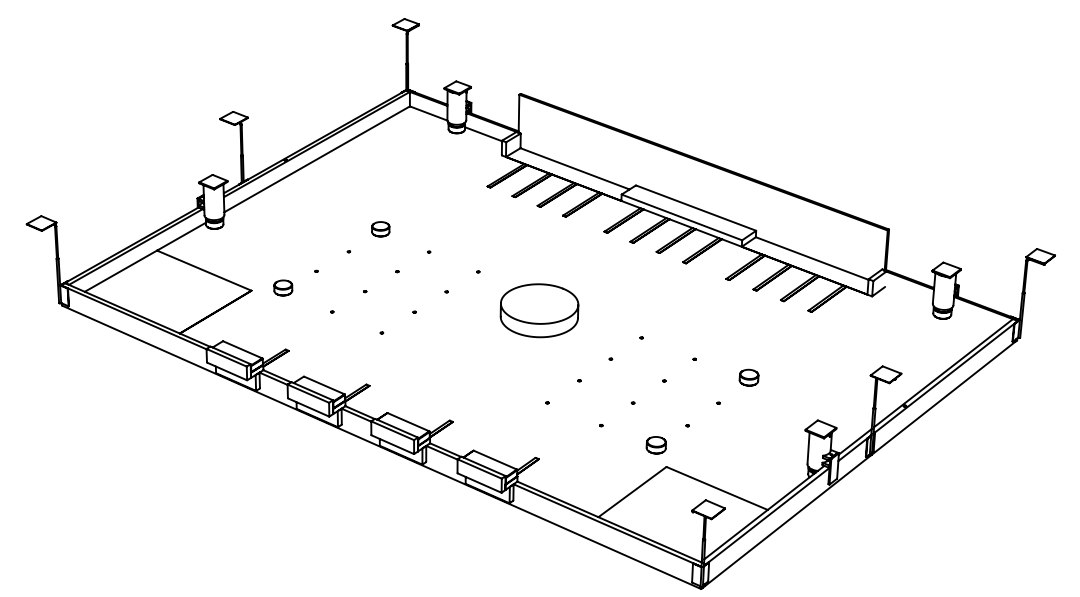

Ⓝ refer to painting references table entries

Painting references (all acrylic matte)		
1		white
2	RAL 6018	yellow green
3	RAL 3020	traffic red
4	RAL 5015	sky blue
5	RAL 8017	chocolate brown
6		black

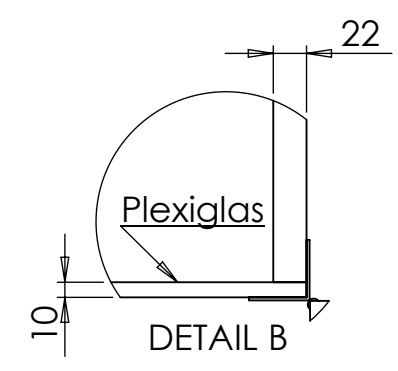

UNLESS OTHERWISE SPECIFIED : DIMENSIONS ARE IN MILLIMETERS			
<b>Eurobot 2009</b>			
TITLE: Table and game elements specifications			
REVISION	1.0	AUTHOR	Eric PASCUAL
		DATE	03/10/2008
SCALE	1:20	SHEET	1 OF 5
		FORMAT	A3



1 2 3 4 5 6 7 8

A A

B B

C C

D D

E E

F F

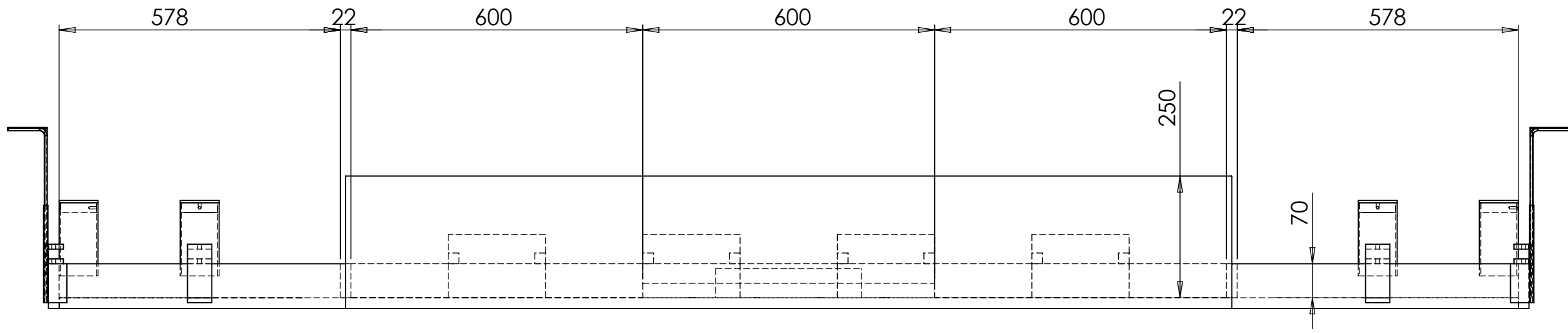

View from front side (audience)

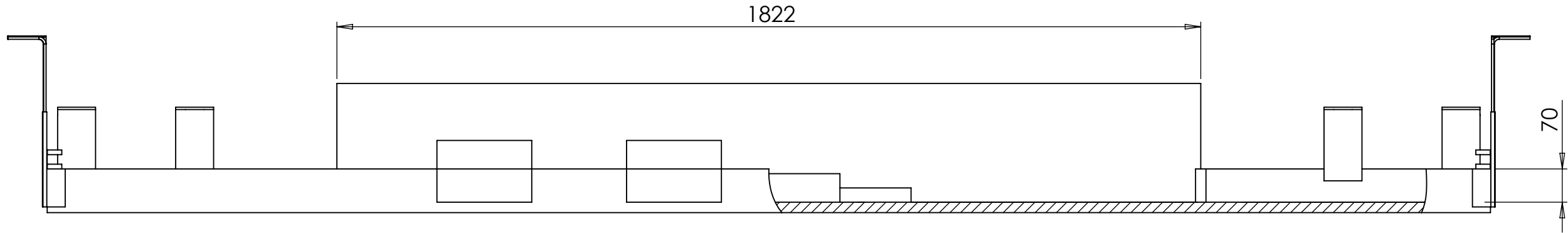

View from back side (with local cross-section)

UNLESS OTHERWISE SPECIFIED : DIMENSIONS ARE IN MILLIMETERS

<b>Eurobot 2009</b>			
TITLE: Table and game elements specifications			
REVISION	1.0	AUTHOR	Eric PASCUAL
		DATE	03/10/2008
SCALE	1:10	SHEET	2 OF 5
		FORMAT	A3

1 2 3 4 5 6

Central construction area

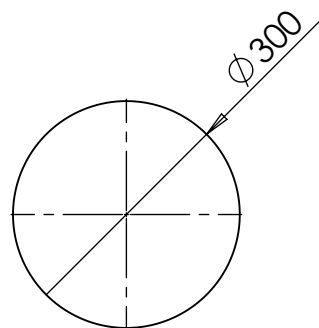
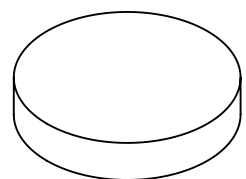

Front raised construction area

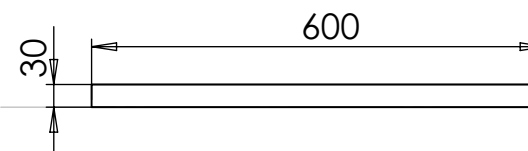
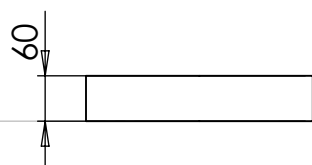
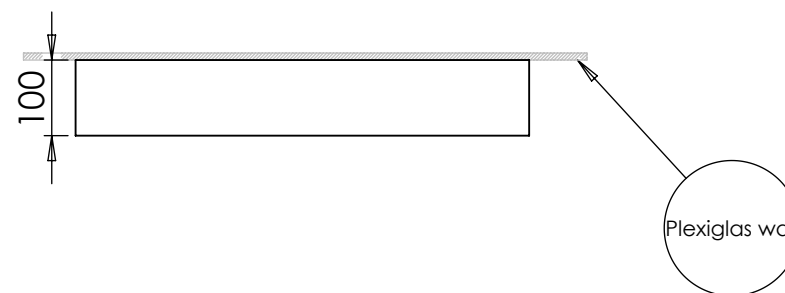
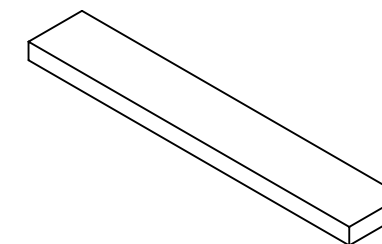

UNLESS OTHERWISE SPECIFIED : DIMENSIONS ARE IN MILLIMETERS

<b>Eurobot 2009</b>			
TITLE: Table and game elements specifications			
REVISION	1.0	AUTHOR	Eric PASCUAL
		DATE	03/10/2008
SCALE	1:10	SHEET	3 OF 5
		FORMAT	A3

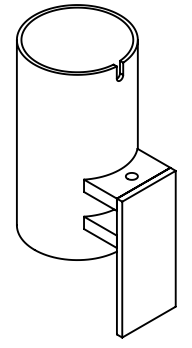
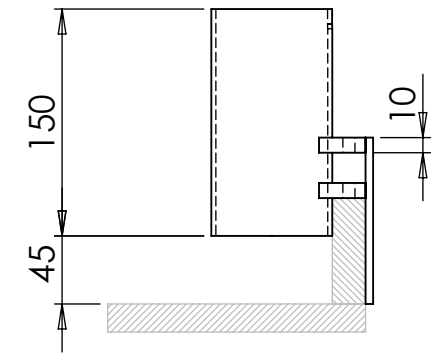
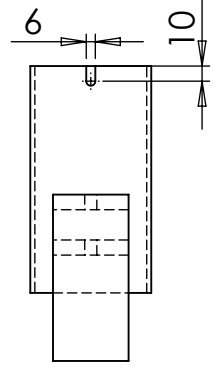

Vertical dispenser

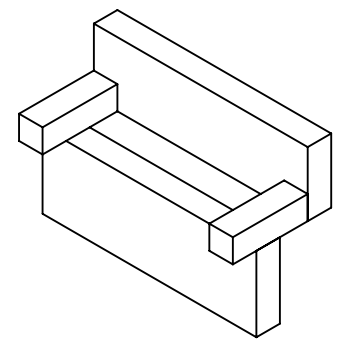

Lintel stand

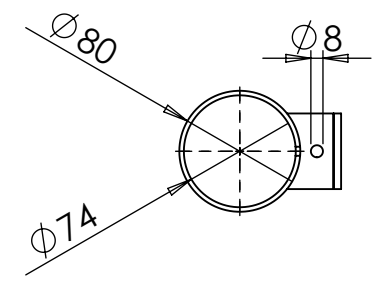

- Notes :
- all parts made of transparent Plexiglas
  - attachment to front Plexiglas wall uses an appropriate spacer
  - D8 holes are for the M8 bolt used to attach the moveable dispensers to the table side walls

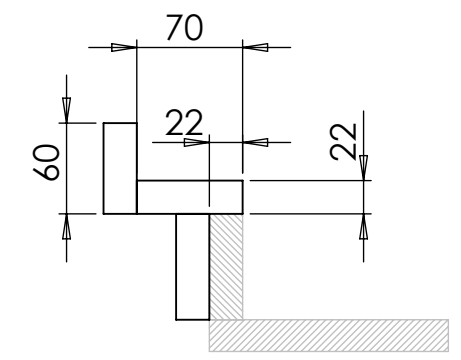
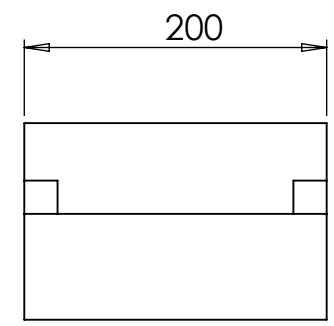

- Notes :
- all parts made of wood
  - all parts painted in black matte

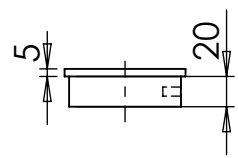
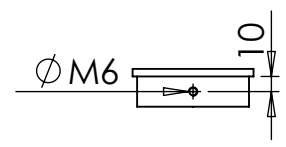

Beacon support for vertical dispensers

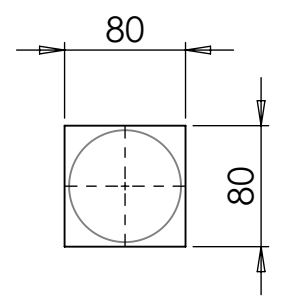
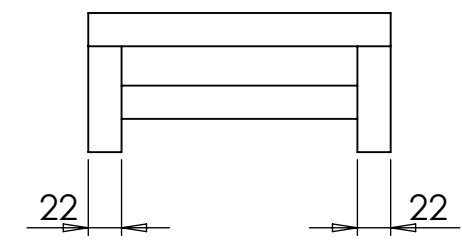

- Notes :
- all parts made of transparent Plexiglas

UNLESS OTHERWISE SPECIFIED : DIMENSIONS ARE IN MILLIMETERS

# Eurobot 2009

TITLE: Table and game elements specifications

REVISION	1.0	AUTHOR	Eric PASCUAL	DATE	03/10/2008
SCALE	1:5	SHEET	4 OF 5	FORMAT	A3

Column element

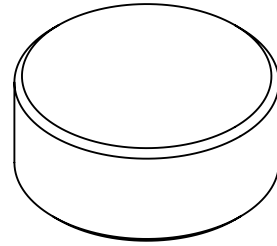

Lintel

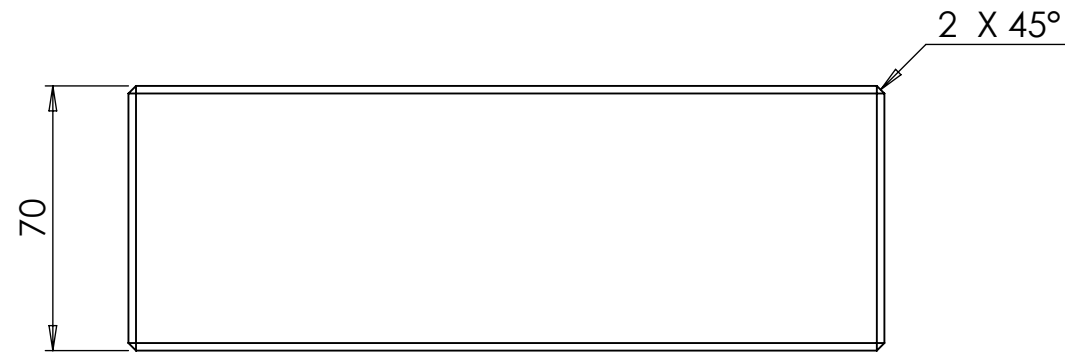
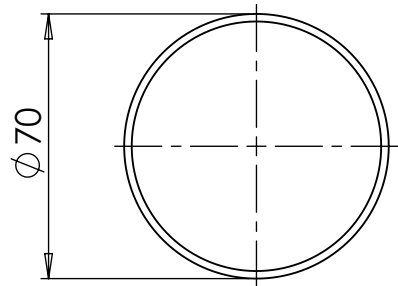
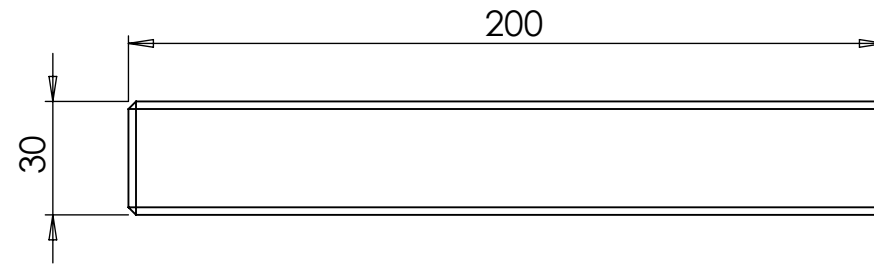
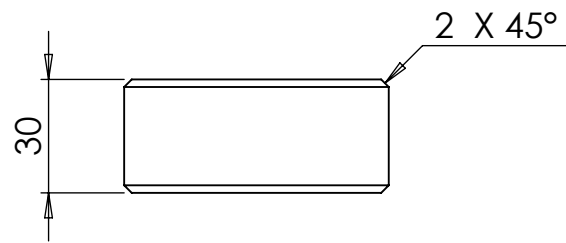
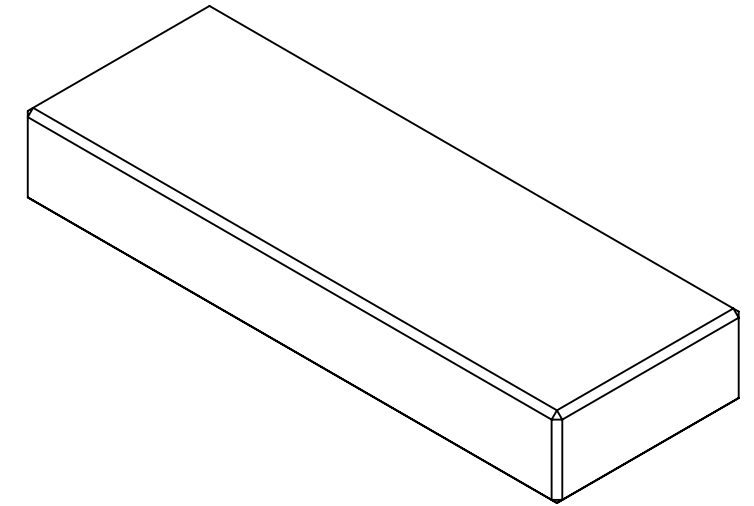

Painting references	
green	RAL 6018
red	RAL 3020

UNLESS OTHERWISE SPECIFIED : DIMENSIONS ARE IN MILLIMETERS

# Eurobot 2009

TITLE: Table and game elements specifications

REVISION	1.0	AUTHOR	Eric PASCUAL	DATE	03/10/2008
SCALE	1:5	SHEET 5 OF 5		FORMAT	A3