

Note: All the pictures in this document are provided for information. They cannot be used as references. Dimensions, colours and materials listed in the appendix are the only to be considered.





ROBOMOVIES



... Rules... Rules... Rules... Rules... Rules... Rules... Rules... Rules... Rules... Rules...

A. Presentation	4
B. Rules of the match	6
C. Playing area and actions	7
1. <u>Playing area</u>	7
2. <u>Starting areas</u>	8
3. <u>The spotlight</u>	9
4. <u>The clapperboards</u>	11
5. <u>The popcorn</u>	11
6. <u>The red carpet</u>	14
7. <u>Climbing the red carpet steps</u>	15
8. <u>The black lines</u>	16
D. Project presentation	17
1. <u>Technical survey</u>	17
2. <u>Technical poster</u>	17
1. <u>Constraints</u>	18
2. <u>Evaluation</u>	18
E. The robots	19
1. <u>Foreword</u>	19
2. <u>Dimensions</u>	20
3. <u>Energy sources</u>	20
4. <u>Design constraints and mandatory equipment</u>	21
5. <u>Safety</u>	23
F. Beacon systems (specific Eurobot ^{Open})	25
1. <u>General points</u>	25
2. <u>Opponent beacon</u>	25
3. <u>Fixed beacon</u>	26
4. <u>Communication signals</u>	26
5. <u>Identification tag</u>	26
G. Match procedure	27
1. <u>The preparation phase</u>	27
2. <u>The match</u>	27
3. <u>The scoring</u>	28





ROBOMOVIES



... Rules... Rules... Rules... Rules... Rules... Rules... Rules... Rules... Rules... Rules...

H. The contests	29
1. <u>Forewords</u>	29
2. <u>Approval</u>	29
3. <u>Qualification phases</u>	29
4. <u>The finals</u>	30
5. <u>Qualification for the national finals</u>	30
6. <u>Qualification for the European finals</u>	30
I. Appendix	32
1. <u>Playing area view from top</u>	32
2. <u>Table (Painting)</u>	34
3. <u>Starting area</u>	35
4. <u>Platform</u>	36
5. <u>Stairs</u>	36
6. <u>Popcorn machine</u>	38
7. <u>Clap left</u>	39
8. <u>Clap right</u>	41
9. <u>Cup</u>	42
10. <u>Stand</u>	43
11. <u>Beacon support middle</u> (specific Eurobot ^{Open})	44
12. <u>Beacon support corner</u> (specific Eurobot ^{Open})	46
13. <u>Painting references</u>	47
14. <u>Material references</u>	47





ROBOMOVIES



... Rules... Rules... Rules... Rules... Rules... Rules... Rules... Rules... Rules... Rules...

A. Presentation

Eurobot^{open} and Eurobot^{open} Junior are two events open to young robotics teams of amateurs. These teams can be composed of students involved in Eurobot^{open} in the frame of a school project, group of friends, or independent clubs. Eurobot^{open} and Eurobot^{open} Junior share the same goal: to allow young people to be involved in an active-learning process and put into practice their knowledge and know-how by participating in a friendly event.

About Eurobot^{open}



The age limit for participating in the Eurobot^{open} final is **30** years. Each team may have a supervisor to whom the age limit does not apply. Teams that do not respect this age limit will not be allowed to participate in the Eurobot^{open} final. The technical challenge is to build an **autonomous robot** as well as an optional secondary autonomous robot.

About Eurobot^{open} Junior

The age limit for participating in the Eurobot^{open} **Junior** final is **18** years. Each team may have a supervisor to whom the age limit does not apply. The technical challenge is to build a **remote controlled robot** as well as an **optional autonomous robot**.



Be careful, according to your country's educational system, this age limit may be slightly different. Check the registration requirements stated by your National Organising Committee.

A team is a group of young people who have built one robot (and optionally a secondary robot) for the event. One person can be part of only one team, **even if both teams belong to the same organization**, but we encourage teams to share their experiences. The project can be supervised by someone over the age limit (teacher, parent, group leader, etc.), but the robot must be designed and built by the team's members, not the supervisor.

One organization (club, school, etc.) can register several teams, if permitted by the registration requirements set by your National Organising Committee. The acceptance of these requirements is compulsory.

Eurobot^{open} and Eurobot^{open} Junior are intended to be held in a friendly and sporting spirit. As in sports event, refereeing decisions are final, except if an agreement between all parties is met.

Countries where more than 3 teams are registered must organize a national qualification, in order to select the teams that will attend the international final. Teams from countries with less than 3 registered teams can attend the international final without needing a national qualification event. These final events take place in Europe, but remain open to countries from other continents.



As usual, some parameters can vary from one year to the next. Accordingly, please read the rules carefully even if the chapters may seem familiar to you (playing field dimensions, robots dimensions, etc.).





ROBOMOVIES



... Rules... Rules... Rules... Rules... Rules... Rules... Rules... Rules... Rules... Rules...

The rules for both events (Eurobot^{open} and Eurobot^{open} Junior) are similar. The aim of this approach is to provide an almost common platform for the Eurobot^{open} event, dedicated to autonomous robots, and for Eurobot^{open} Junior event, dedicated to wire-guided robots.

Thus:

- An Eurobot^{open} organizer has also the ability to organize a Eurobot^{open} Junior contest, and vice versa.
- The exchange of experiences is favoured between participants from the two events.

WARNING! This document presents the Eurobot^{Open} and the Eurobot^{Open} Junior rules. To distinguish between them, you will find information dealing with Eurobot^{Open} in **blue** and Eurobot^{Open} Junior in **yellow**. Information common to both rules is in **black**.



B. Rules of the match

Becoming a movie star isn't easy: acting isn't enough! The robots will experience it this year, and will have to show us their multiple talents in an extraordinary shoot.

Tasks:

- **The spotlight:** The robots will have to install them as high as possible in order to illuminate the movie actors.
- **The clapperboard:** The robots will have to close their clapperboards.
- **The popcorn:** The robots will have to gather popcorn and put it in their popcorn basket.
- **The red carpet:** The robots will have to roll out the carpet on the steps in order to welcome the artists.
- **Climbing the red carpet steps:** The robots will have to go the top of the steps before the end of the match.

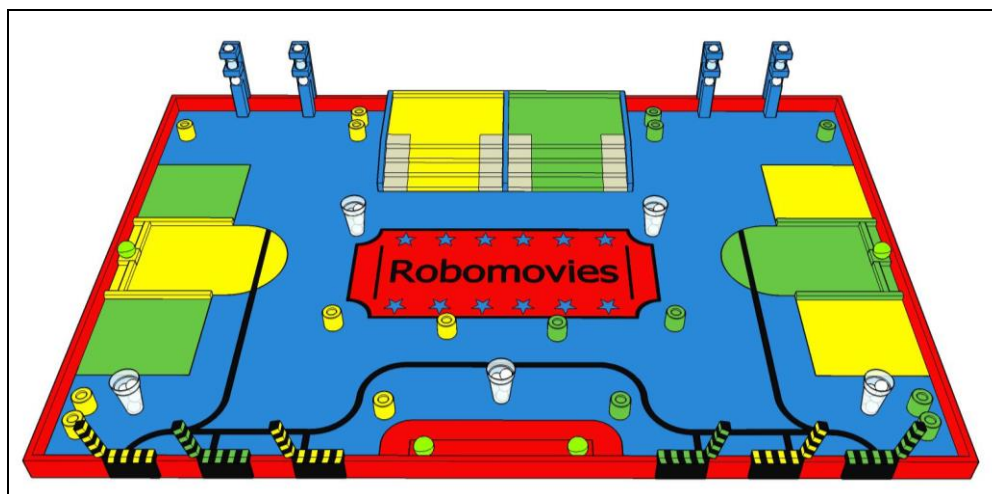

Figure 1: Overview of the playing area (table and elements)

Warning:

- The tasks are independent from each other and no order is required in fulfilling them.
- No task is mandatory. Define your priorities.



C. Playing area and actions

Important information:

Organizers commit themselves to build the playing area with as much accuracy as possible. Nevertheless, they reserve the right to some modifications if they think it is necessary. No objections regarding differences in dimensions will be taken into account. Eventual changes of the technical specifications will be announced on the website of the National Organization Committee (NOC) in your country.

Teams are advised that the quality of the painting on surfaces can vary from one table to another, and can deteriorate as time goes by.

If any problems concerning the rules occur, the specifications of the playing area and its elements could be changed during the year. We therefore strongly encourage the participants to check our website regularly: <http://www.eurobot.org/> as well as your NOC's own website for news. You can also follow the discussions and get further information in the forum: <http://www.planete-sciences.org/forums/>

1. Playing area

The playing area is a 3000x2000 mm rigid rectangular flat, which can be made in two parts of 1500x2000 mm or more. References are provided in the appendix.

This playing area is 10% tilted towards the public for EurobotOpen Junior.

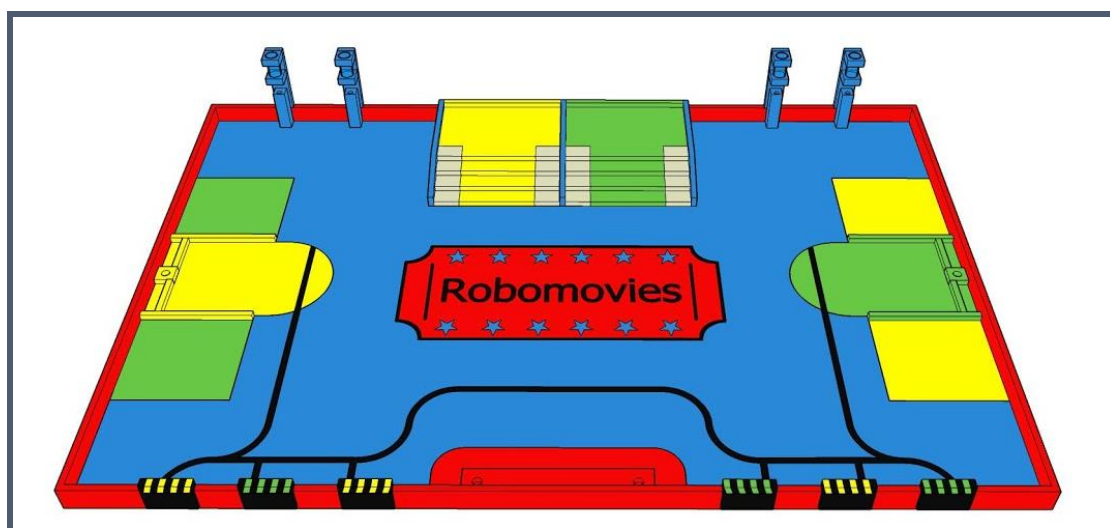

Figure 2: Overview of the playing area without elements





Full specifications of the playing area and playing elements (dimensions, positions at the beginning of the match, colours and other references) are listed in the appendix.

In the rest of the document, horizontal and vertical directions are stated relative to the playing area.



2. Starting areas

a. Description

Starting areas are located on the left and right sides of the playing area. They are represented by an area painted with the colour of the team. The wooden borders of the area are included in the starting area whereas the playing area borders are not.

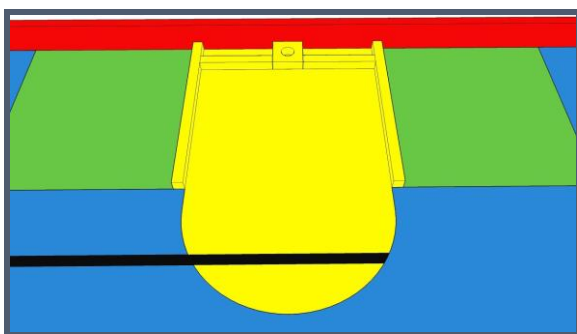

*Team A starting area
(On the left from audience's view)*

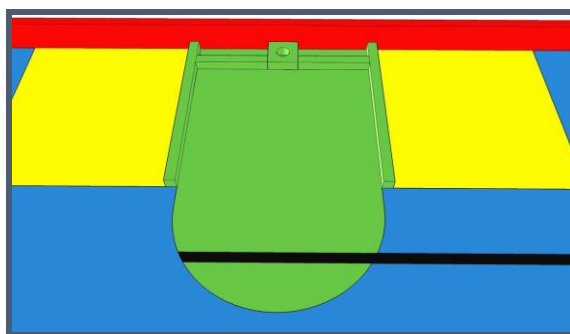

*Team B starting area
(On the right from audience's view)*

Figure 3: Overview of starting areas

b. Constraints

- The robots are not allowed to enter the starting area of the other team.
- Before starting, the robots must stand entirely within the limits of the starting area. Please make sure that your robots can stand together in the starting area.



3. The spotlight

The actors will have a hard time acting without light on the scene! The robots will have to become light directors for a moment.

a. Description of the playing elements and layout

- **The light bulbs:** They are represented by 4 balls and are common to both teams. At the start of the match, they are placed like this:
 - One ball in each starting area.
 - Two balls in the common building area. Alternatively, a ball can be pre-loaded into a robot (the ball on the left for the team in the left starting area, the ball on the right for the team in the right starting area).
- **The stands:** They are represented by cylinders painted with the teams' colours. 8 stands will be attributed to each team.
- **The building areas:** The playing area has 3 building areas:
 - Each team has a protected building area: it is their starting area.
 - There also a building area common to both teams. It is located at the front center side of the playing area from audience's view.
- **The platforms:** They are raised areas, located in each building area.
 - In the starting areas, it is a square.
 - In the common building area, it is a rectangular strip.

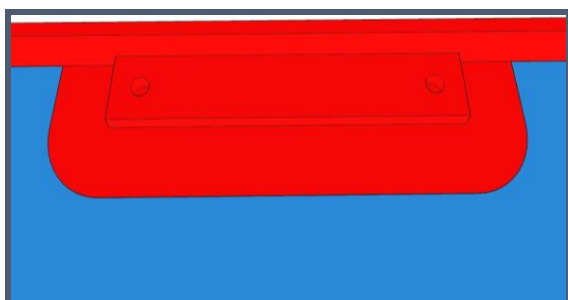

Figure 4: Building area

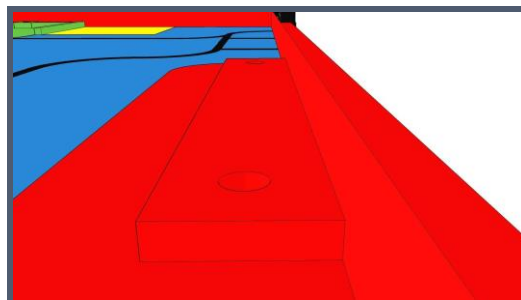

Figure 5: Platform

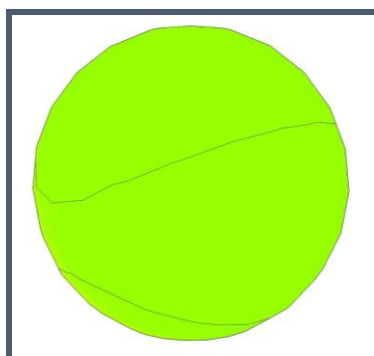

Figure 6: Light bulb



... Rules... Rules... Rules... Rules... Rules... Rules... Rules... Rules... Rules... Rules...

b. Actions and constraints

A spotlight is a stack of one or more stands which is topped by a light bulb.

Actions:

- The robots must bring the stands to the building area.
- The robots must place the light bulb as high as possible in order to build the spotlight that lights the actors.

Constraints:

- A stand is valid only if it has been placed horizontally (flat, so that its axis is vertical) and if it is located, at least partially, inside one of the building areas.
- A stand can be counted for only one spotlight.
- In a spotlight, only one stand can be counted for each team and for each level.
- In each starting area, all of the stands will be counted but only one stack will be counted as a spotlight.
- In a building area, the height of a playing element can be over the 350 mm limit.
- In the common building area, only the points marked on the platform can not be taken by the other team.
- The robots are not allowed to handle the opponents' stands.
- If points on platforms have been taken from the opponent:
 - As compensation, a three-level stand will be counted in addition for the offended team.
 - A penalty corresponding to a three-level stand will be given to the offending team.

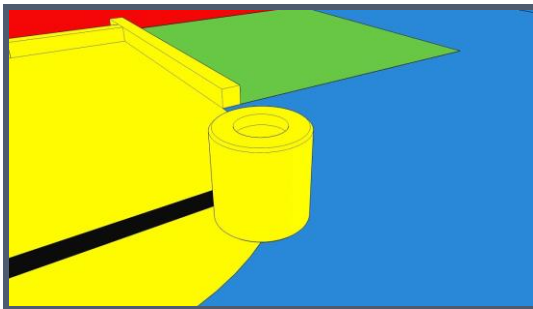

Figure 7: Valid stand

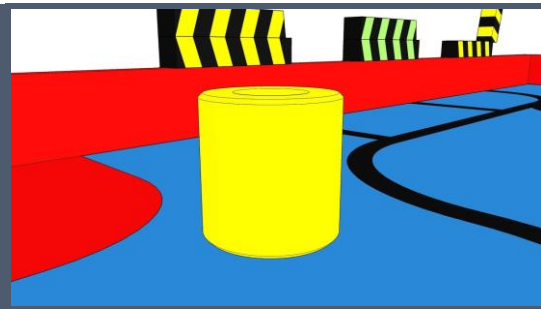

Figure 8: Invalid stand

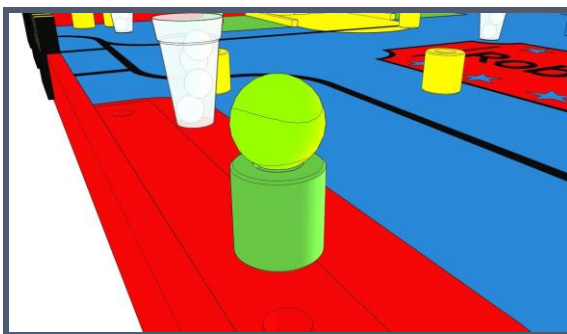

Figure 9: Valid spotlight

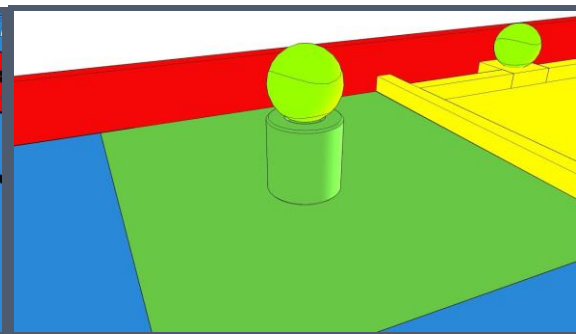

Figure 10: Invalid spotlight



... Rules... Rules... Rules... Rules... Rules... Rules... Rules... Rules... Rules... Rules...

4. The clapperboards

In order not to mix the scenes of the movie during its editing, we are counting on the robots to become clapper loaders !

a. Description of the playing elements and layout

- **The clapperboards:** They are located at the front of the playing area. Three clapperboards are attributed to each team. They are colored with the team's colour and are open at the start of the match.

b. Actions and constraints:

Actions:

- The robots have to close the clapperboards of their colour.

Constraints:

- The robots have to close only the clapperboards of their colour. If a robot closes a clapperboard of the other team, the points of the action will be given to the opposing team at the end of the match.

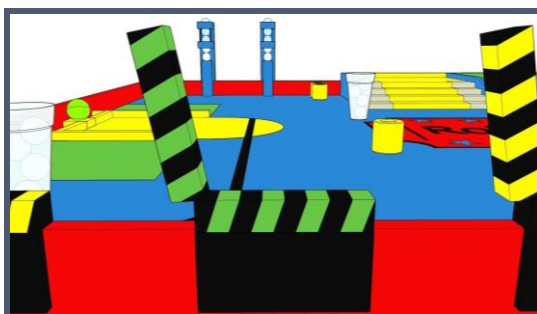

Figure 11: Open clapperboard

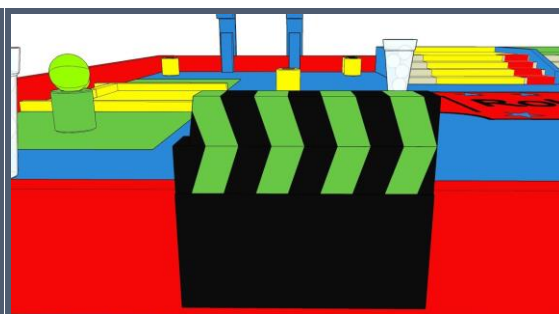

Figure 12: Closed clapperboard

5. The popcorn

The robots are also gourmand. Bring them to the cinema and, as their human friends, they will rush for the popcorn.

a. Description of the playing elements and layout

- **The popcorn:** It is represented by balls. At the start of the match, it will be distributed into the popcorn baskets and into the popcorn machine.
- **The popcorn cups:** They are represented by 5 glasses. At the start of the match, each cup is filled with 4 popcorns. The cups can be moved.
- **The popcorn machines:** 4 machines, which are represented by vertical columns, that are located on each side of the steps. At the start of the match, the machines are filled with 5 popcorns that can be collected by the robots.
- **The cinemas:** They are represented by areas drawn on the playing area. They are painted with the teams' colours. 3 cinemas are attributed to each team. The first cinema is the starting area of the team. The two others are located on the right side and the left side of the opposing team's starting area.



... Rules... Rules... Rules... Rules... Rules... Rules... Rules... Rules... Rules... Rules...

- **The popcorn baskets:** These drop areas are located at the back of each team's starting area.

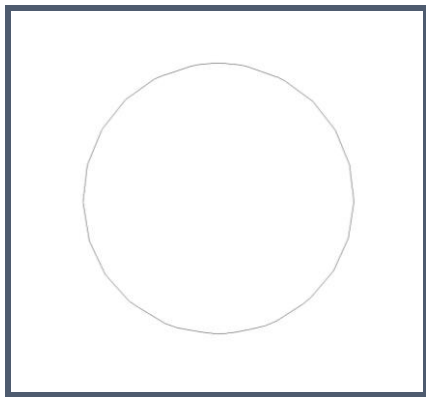

Figure 13: Popcorn

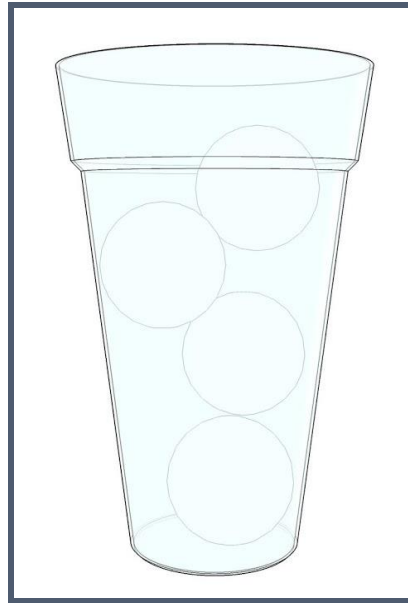

Figure 14: Popcorn cup

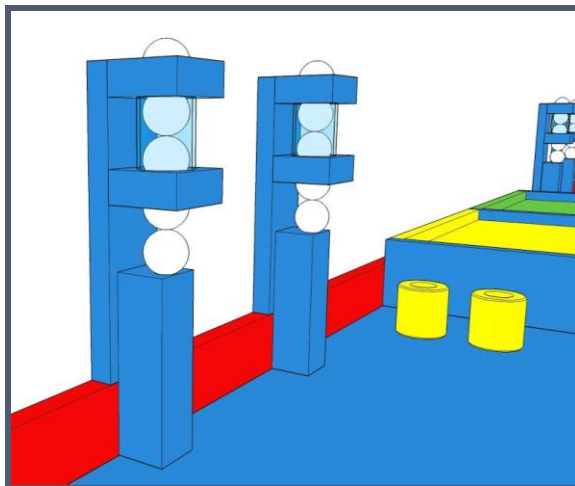

Figure 15: Popcorn machine



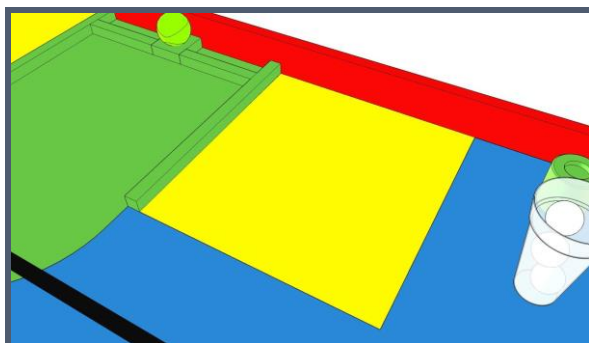

Figure 16: Cinema



Figure 17: Popcorn basket

b. Actions and constraints

Actions:

- The robots have to bring:
 - Popcorn cups in their cinemas.
 - Popcorn in their popcorn baskets.

Constraints:

- A popcorn cup is valid if:
 - The cup has not been knocked over.
 - And its base is, at least partially, inside a cinema.
- In each cinema, only the most filled cup will be counted.
- With the exception of the starting areas, the robots are allowed to enter the opposite team's cinemas.
- The robots can add popcorn in the cups.
- In this action, the playing elements are common to both teams. Points can be taken from the opposite team at any time. Only the position at the end of the match will be taken into account.

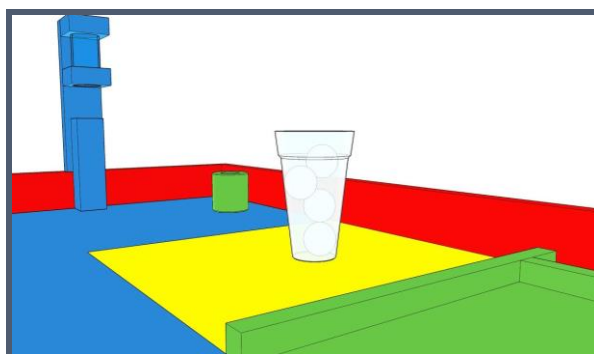

Figure 18: Valid cup

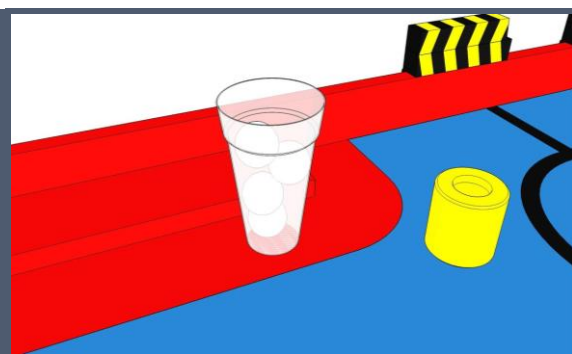

Figure 19: Invalid cup



6. The red carpet

Being a glamorous and essential asset to the prestigious scenery of our cinema, the red carpet will have to be installed in order to honour the artists.

a. Description of the playing elements and layout

- **The stairs:** They are located at the back of the playing area (from audience's view). There is one stairway for each team.
- **The walkways:** They are represented by the areas painted with the neutral colour on the stairways. There are 2 walkways on each stairway.
- **The steps:** They represent the 4 levels of the walkway.
- **The red carpets:** They are represented by pieces of tissue that are given by the organization.



Figure 20: Stairway

Figure 21: Walkway

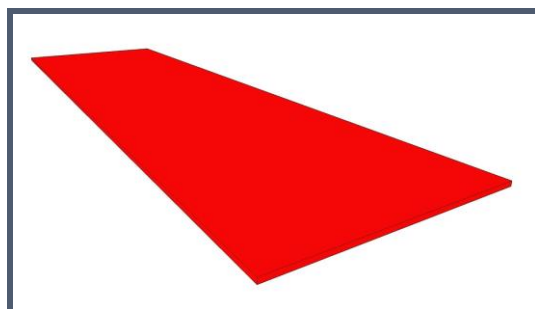

Figure 22: Red carpet

b. Actions and constraints

Actions:

- The robots have to put the red carpet on the steps in order to welcome the artists.

Constraints:

- Only one carpet will be counted for each walkway.
- A red carpet is only valid if it covers partially or totally a step of a walkway painted with the colour of the team. Also the carpets must be detached from the robots at the end of the match to be valid.



... Rules... Rules... Rules... Rules... Rules... Rules... Rules... Rules... Rules... Rules...

- Before the start of the match, each team can load 2 carpets in its robots. Carpets not used by the team will be removed from the playing area.

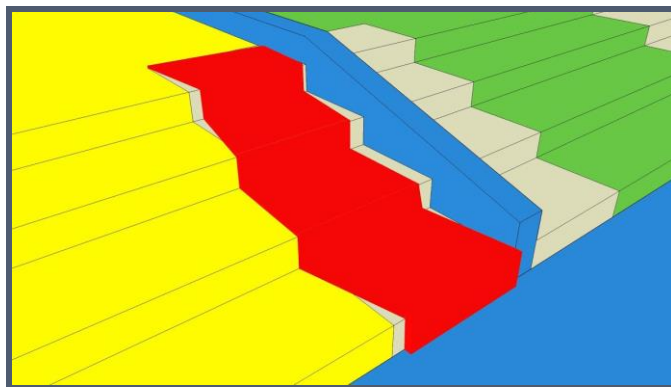

Figure 23: Carpet laid on the steps

7. Climbing the red carpet steps

After having participated so much to the shooting of the movie, the robots deserve to be rewarded for their hard work ! They will have the pleasure to climb the red carpet steps.

a. Description of the playing elements and layout

- **The top of the steps:** It is an area located at the top of the stairways, at the back of the playing area (from audience's view).



Figure 24: The top of the steps

b. Actions and constraints

Actions:

At the end of the match, one robot of each team has to be at the top of the steps..

Constraints:



... Rules... Rules... Rules... Rules... Rules... Rules... Rules... Rules... Rules... Rules...

- A robot is only allowed to climb on the stairway painted with its team's colour.
- On the steps, the robots can be above the 350mm height limit.
- During the climbing of the steps, the robots are no longer constrained by the height limit of the rules

8. The black lines

A black line is available for each team in order to do line tracking.
This line starts from the starting area of the team and leads to the clapperboards.

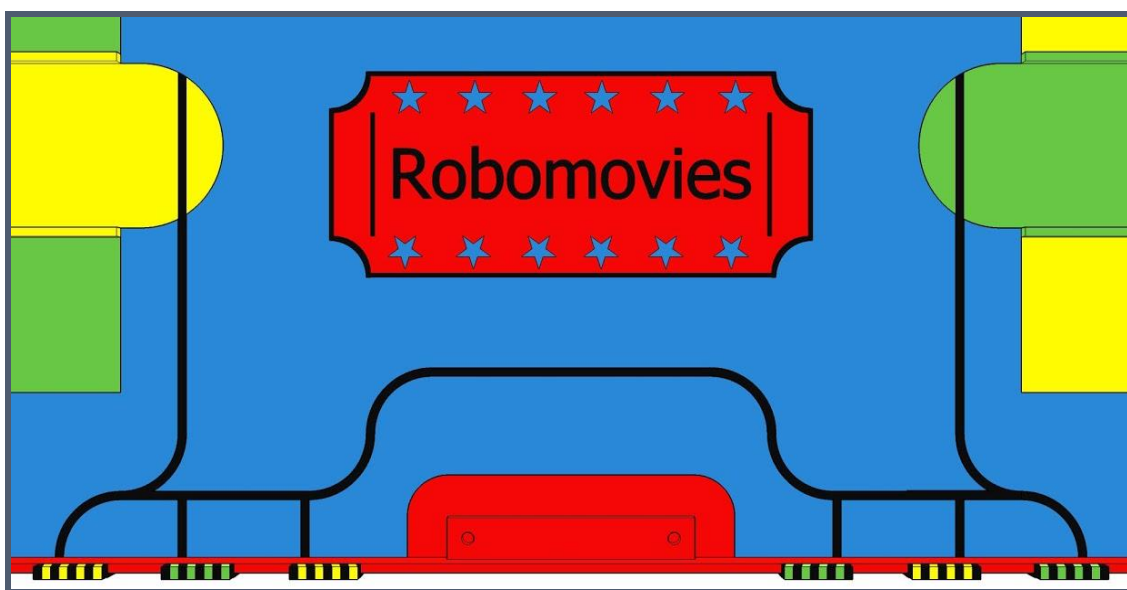

Figure 25: Black lines





ROBOMOVIES



... Rules... Rules... Rules... Rules... Rules... Rules... Rules... Rules... Rules... Rules...

D. Project presentation

Both Eurobot^{open} and Eurobot^{open} Junior encourage you to practice science through entertainment. One of the fundamental objectives is to assist and value your work and projects of this year. To achieve this, we require you to make a Technical survey and a Poster.



A.Eurobot^{Open}

1. Technical survey

Over the year, each team is required to submit a technical survey to the refereeing committee; your national organizer specifies the submission deadline. The purpose of this paper is to provide a clear and concise vision of your project, focusing on 2 topics:

- General information (team, schedule, budget)
- Technical information (strategy, technical choices, etc.). It should include details about mechanics, electronics and the software your team plans to use. If possible, your technical survey should include illustrative charts and pictures. This part must be written using a template (downloadable from the registration website).

The goal of the technical survey is not to give the teams more work, but to help them to complete their projects successfully. The refereeing committee will read it carefully in order to identify possible misunderstandings of the rules, etc. in the development process as soon as possible.

Thus it will allow us to identify doubtful solutions and to help the teams to avoid failure situations.

2. Technical poster

Each team is required to provide a technical poster. This poster should present information related to the design of the robot (drawings, technical references, design specifications, etc.). It should be at least DIN A1 (594x841 mm) in size, and ideally should be printed. The poster is intended to promote exchange and communication between teams.

Special effort should be made to make the poster **understandable to a novice audience**. Ideally the poster should include pictures and charts to explain the concepts.

The poster must also include:

- the team's name,
- the team members' names,
- the team's nationality.

This poster will be displayed in the team's stand. An English version of the poster must be supplied. Optionally, the team can provide other language versions as well. The poster must be supplied to the Eurobot^{open} association in PDF Format.

The chosen resolution of the PDF must guarantee that all texts on the poster will remain readable. If possible, the file size of the PDF should remain below 25 MB.





ROBOMOVIES



... Rules... Rules... Rules... Rules... Rules... Rules... Rules... Rules... Rules... Rules...

The PDF version of the poster may be sent to Eurobot^{open} beforehand via your National Organizing Committee. It may also be provided on CDROM or USB key during the contest when presenting your robots for the approval. In a general way, we strongly encourage the teams to discuss their projects by posting information on the internet or for example in the Eurobot^{open} forums.



B.Eurobot^{Open} Junior

As in the previous years, the presentation of your team's project (through project management on the long-term, tasks distribution ...) as well of your robots (technical systems implemented, chosen strategies ...) is an integral part of the event. Teams should present their projects in a way that is easily understandable and visible for the public and the other participants.

1. Constraints

This presentation should be done on a poster with a size of at least DIN A1 (594x841 mm). It is also possible to add further presentation supports (like video). Be creative !

2. Evaluation

The project should be presented to the referees and "guardian angels" during the approval of the robots in order to show the whole work. This presentation will be taken into account for the approval process. During the event, a jury will examine all the posters and discuss with all present teams, in order to be able to give an "award for the best-presentation".





ROBOMOVIES



E. The robots

1. Foreword

- Each team is allowed to register a maximum of two robots which are referred to as the “main robot” and the “secondary robot”. The secondary robot has different constraints to its dimensions.
- For Eurobot^{Open} Junior, the main robot is wire-guided and the secondary robot is autonomous.
- For Eurobot^{Open} both robots are autonomous.
- The construction of a secondary robot is optional. For beginner teams that are new to Eurobot it is recommended to focus on building a single robot. In general it is better to have one working robot instead of two robots that are barely finished. Having a secondary robot allows larger teams with more members to split their work into two projects.
- The secondary robot can participate only with the main robot it has been created for and approved with. However it can participate alone if the main robot cannot participate. It cannot be re-approved with another robot.
- A robot must not damage the opponent, the playing area or its elements.
- During the contest, only two members per team are allowed on stage and in the backstage area. The path to the stage may contain steps or stairs. Therefore it is recommended to make the equipment easy to transport.
- Both the main and the secondary robots must each consist of interconnected parts. Hence they are not allowed to leave or lose any parts on the playing area with the exception of playing elements.
- The use of objects, graphics or colours resembling the table or its playing elements is against the idea of fair-play and must not be used on the robot(s). This will be checked during the approval.
- The robots are not allowed to fixate themselves on the playing area (for example by suction). The force needed to lift a robot vertically must never exceed its weight.
- The robot(s) shall never prevent the opponent’s robot(s) from scoring points, in particular blocking the access to playing elements. If a robot is motionless after for example finishing a task it should clear the area. However, blocking the access to already scored points is allowed.
- Deliberately making the table vibrate or other similar actions will not be approved. If you are in doubt please contact the referees.
- Use your imagination and be creative ! Your robot can show emotions, play sounds or music to provide the audience and media with an attractive show.





2. Dimensions

The dimensions of the main and the secondary robot in Eurobot^{Open} are identical to the ones in Eurobot^{Open} Junior. Thus, a robot built for Eurobot^{Open} Junior can potentially compete in Eurobot^{Open}. The Eurobot^{Open} Junior robot would only need to be modified in order to be autonomous.

Dimensions of the main and the secondary robot:

The perimeter is measured according to the figure below:

Dimensions of the main robot:	Dimensions of the secondary robot:
 <p>Start configuration ≤ 1200 mm</p> <p>Deployed ≤ 1500 mm</p>	 <p>Start configuration ≤ 700 mm</p> <p>Deployed ≤ 900 mm</p>

The perimeter of the main robot must not exceed 1200 mm at the beginning of a match. This is called the “starting configuration”. During the match the robot may deploy to a maximum perimeter of 1500 mm which is called the deployed configuration.

The secondary robot’s perimeter is independent from the main robot’s perimeter. At start it must not exceed 700 mm but can extend up to 900 mm in the deployed state during a match.

In any case the height of the main robot and the secondary robot must never exceed 350 mm. The emergency button is allowed to exceed this limit but must stay below 375 mm in height.



For Eurobot^{Open} this height excludes the beacon support, sensors and electronic circuits that can be placed below the beacon support.

No components of the robot and playing elements manipulated at any moment by the robot should exceed 350 mm in height, in order not to disturb the beacons.



At the beginning of a match both robots together must be completely inside the starting area and may not exceed its limits.

3. Energy sources

In general, all forms of energy sources stored in the robot are allowed (batteries, springs, compressed air, gravitational energy...). Energy sources using chemical reactions like





ROBOMOVIES



... Rules... Rules... Rules... Rules... Rules... Rules... Rules... Rules... Rules... Rules...

combustion or pyrotechnic processes are prohibited for safety reasons. Any corrosive products or other liquids that can splash are not allowed for the same reason. It is also prohibited to use living beings inside the robot.

- If you have any doubts about an unusual energy source, please ask the referees in time.
- To prevent the risk of fire, special attention should be paid to the choice of conductors, depending on the intensity of current passing through them. It is also recommended to protect the wiring with a fuse that should be placed as close to the batteries as possible.
- Beware! Power supply systems must be easily transportable. Teams may have to walk up/walk down stairs to access the stage where the matches take place.
- Only electric energy can be transmitted to the robot. The maximal voltage allowed is 13.8V (measured between two wires of the cable and of the robot). The organizers do not provide this energy source during the event. Teams will have access to the standard 230V, 50Hz. In case of using batteries, these ones should be waterproof. The terminals must be insulated.



Batteries

Both robots must be able to play at least three matches consecutively. Please note that this also includes the time during the preparation phase before the match itself. During this phase the robots have to stand by waiting for the start signal. For details on the procedures of a match please take a look at chapter **Erreur ! Source du renvoi introuvable..**

Therefore, it is strongly recommended to have several sets of batteries with the possibility to change them easily without too much effort. It is also very advisable to keep a set of batteries fully charged at any time.

Special note for batteries based on Lithium:

These types of batteries are permitted only under strict conditions:

- A charger suitable for the batteries in use must be presented during the approval.
- The batteries must remain inside certified and unaltered safety bags at any time. (This includes also the time when they are not in use or being recharged)
- A system to detect and prevent undervoltage is strongly advised.
- Those restrictions do not apply if the batteries are inside commercial products such as laptops, mobile phones or LEGO NXT and only if they are not altered or modified in any way.

4. Design constraints and mandatory equipment

i.....Common part

a. Visibility

The organizers of the event may want to place stickers containing the team number and sponsors on your robots. Two rectangular areas of 100x70 mm have to be provided for this purpose on each robot. The team can choose the position of the areas as long as they are on two different sides of the robot.





ROBOMOVIES



... Rules... Rules... Rules... Rules... Rules... Rules... Rules... Rules... Rules... Rules...

The teams are strongly encouraged to make the mechanism inside the robot visible to the audience and other participants. It is in the spirit of education and knowledge-transfer to understand how the robots function.

b. Starting cord of autonomous robots

At the beginning of a match the robots must be started with a so called starting device. This device has to be triggered by pulling a cord with a length of at least 500 mm. After being pulled, the cord must be detached completely from the robot. Any other devices like a remote control, activating a switch by hand or releasing the emergency button will not be approved.

The only exception is the secondary robot which can also be triggered by the main robot. Therefore it does not need have a starting cord.

c. Emergency stop button of autonomous robots

All robots must be equipped with an emergency stop button. This button has to be of red colour and must have a diameter of at least 20 mm. **It must be placed on top of the robot in a spot that can be accessed safely by the referees at any time during the match.**

The button may exceed the height limit of 350mm by additional 25mm in the released state (that means not pushed down).

A simple downward movement, for example by the hit of a fist, must actuate the button.

After pushing the button all actuators of the robot must shut down and stay limp, that means neither actively braked nor energized.

d. Automatic shutdown (optional for Eurobot^{Open} Junior)

Both robots must be equipped with a timer that stops the robot and its actuators after the 90 seconds of a match.

e. Obstacle avoidance system (optional for Eurobot^{Open} Junior)

An obstacle avoidance system needs to be installed in the main robot and in the secondary robot.

The objective of such system is to prevent collisions with opponent robots which could lead to damages and loss of orientation.

Warning: Most events are filmed or photographed. Some cameras use autofocus systems with infrared light that could have a negative effect on your robot's sensors. Please make sure your system is robust against this influence.



ii.....Eurobot^{Open}

Beacon support

It is strongly recommended to equip your robots with a beacon support. Its purpose is to allow the opponent to put a beacon on top of each of your robots to be able to detect it.

This support can be made removable to only be mounted if needed. In that case the teams must be able to set it up quickly prior to a match.





ROBOMOVIES



... Rules... Rules... Rules... Rules... Rules... Rules... Rules... Rules... Rules...

The beacon support is optional. A team can also choose not to facilitate their robots with it. In a match with an opponent that depends on putting a beacon on your robot you will not be able participate. It will be considered as a scratch for your side.

The beacon support should at all times comply with the following specifications:

- It needs to have an 80x80 mm square surface, located at 430 mm above floor level. This is where the opponent's beacon will be placed.
- The surface of this platform has to be entirely covered with Velcro (the rough "hook" side)
- The structure supporting the platform (mast) must stay within the vertical projection of this platform.
- The mast can only host sensors and electronic circuits that also need to stay inside the platform's vertical projection.
- The mast should be stable and must be able to support a weight of at least 400 g.



iii.Eurobot^{Open} Junior

a. Main robot control system

The Control panel

Each team must design a control panel for its main robot that may only be operated by a single pilot. The control panel is an in-box system allowing the control all the electrical devices of the robot. It is the only authorized communication device with the robot. As a consequence, any other remote control device is strictly forbidden.

The cable

The cable linking the robot to its control panel is not provided, it must be designed and built by each team, according to its own needs. For the reason of sufficient mobility on the playing area it should be at least 5 meters long. It will be supported by the co-pilot with a pole provided by the organizers. During the match, the co-pilot should interfere neither in the piloting nor in the robot's settings (like the voltage for example). Furthermore, the cable must not be used to guide the robot or to put it upright again after it fell down. Such action can be penalized.

b. Secondary robot control system

Teams can use any kind of control system for their secondary robot (analogue, microprocessor-based, microcontroller-based, embedded computer, programmed...). These systems must be entirely embedded in the secondary robot. The control system must allow the robot to play a match in the role of both colours. Ideally, this technical point should be configured just before the match starts.

5. Safety

a. General

- All systems (i.e. robots and beacons) should comply with current national and European safety regulations. They must endanger neither the participants nor the audience during matches, as well at stands and backstage.
- The robots must not have any protruding or sharp parts that can cause injuries or damage to the table, its playing elements or other robots.
- The use of liquids, corrosives, pyrotechnics and living components is strictly prohibited.





ROBOMOVIES



... Rules... Rules... Rules... Rules... Rules... Rules... Rules... Rules... Rules... Rules...

- All robots must comply with the legal standards for “low voltage”. Therefore, **the internal voltage of the robots and beacons must not exceed 48 V.**
- Potentials higher than 48 V are allowed only inside sealed commercial devices which comply with national and European regulations (such as lasers or LCD display back lighting). Those devices must be left unmodified and unaltered.
- As a general rule, any device or system considered as potentially dangerous by the referees will be rejected. It must be removed from the robot prior to the competition, or will result in the team's disqualification.

b. Lasers

Only considerations based on the laser class definition “EN 60825-1:2007, Edition 2 -Safety of laser products– Part 1: Equipment classification and requirements” will be taken into account.

Teams using a laser have to provide either the classification notice of the equipment or the laser component data sheet. Not being able to provide such a document will prevent the robot from being approved.

Based on this classification, the classes **1 and 1M are allowed without any restrictions.**

Class 2 lasers are only allowed if the projected spot stays inside the table at any time.

All other classes (i.e. classes 2M, 3R, 3B and 4) are prohibited.

Caution: A laser device consists of the laser source, its electronics and the optics. Disassembling or modifying any of those components often leads to a change of classification. Only commercial products with unaltered components can be approved for Eurobot.

c. Powerful lights

Be aware that powerful light sources such as high intensity LEDs can be dangerous for the human eye. Be responsible if you want to make use of such devices and be aware that people around the robot may not expect it.

d. Compressed air system

The pressure in systems using compressed air may not exceed 400kPa (4 bar).



F. Beacon systems (specific Eurobot^{Open})

1. General points

Teams can use beacons around the playing area and on the opponent robot(s) to design a system for localization. The table provides three support platforms for each team to place beacons upon. These beacon supports are located on fixed positions as indicated by the figure below.

All beacons, i.e. those around the table and on the opponent robot(s) must have Velcro on the bottom side. It has to be the soft ("loops") side of the Velcro. Beacons need to remain on their supports for the entire match.

All points regarding the safety of robots also apply to the beacons.

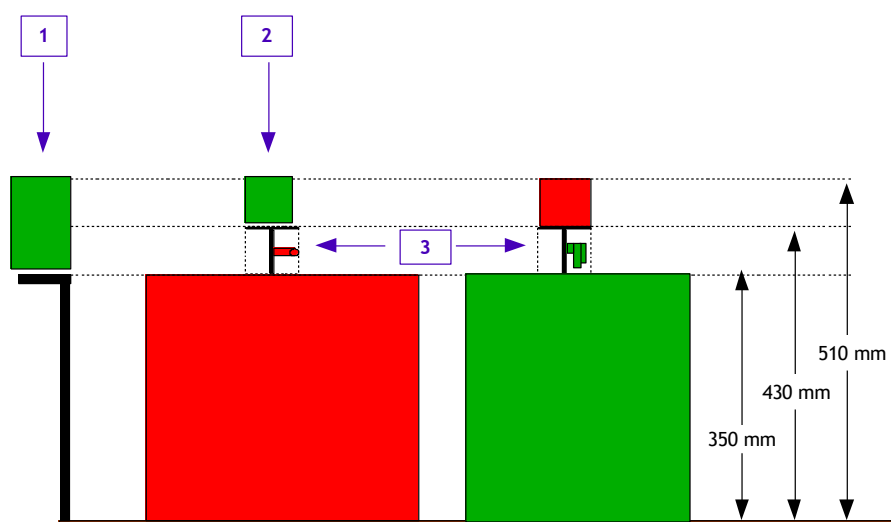

Legend:

- Fixed beacon (maximum size: L x W x H: 80 x 80 x 160 mm)
- Opponent beacon (maximum size: L x W x H: 80 x 80 x 80 mm)
- Mast to support the platform. Sensors and electronics may be placed around the mast as long as they stay within the vertical projection of the platform

2. Opponent beacon

A beacon can be placed on top of each opponent robot. It can be used to localize the robot for the obstacle avoidance system.

This beacon must not exceed the size of a cube with 80 mm edges. In the spirit of fair play the beacons may only contain components that have a real use.

Additionally, opponent beacons also need to have Velcro on the topside. It has to be the rough ("hook") side. During the matches a tag indicating the team's colour will be placed on top of it.

A beacon must not exceed 400g.



3. Fixed beacon

Each team can place three beacons on fixed locations around the table. Those locations are defined by the team's colour in the match as indicated in the figure below. The dimensions of the beacons must not exceed a cuboid with a base of 80 x 80 mm and 160 mm height.

The fixed beacons can be connected to each other using a wire. This wire must not disturb the match in any case.

The setup of the whole system must be possible during the 3 minutes preparation phase prior to the match and must not disturb the opponent team.

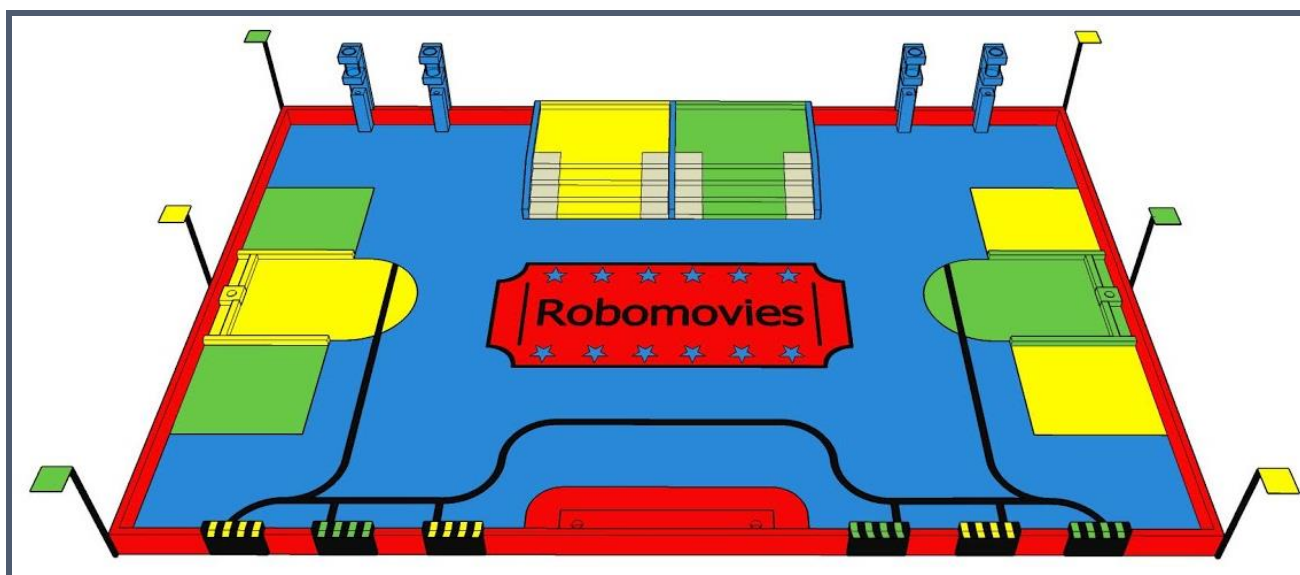

Figure 26: Location of the fixed beacons and their assignment to the teams

4. Communication signals

It is recommended to encode all communications to avoid interferences between the signals of different teams.

The organizers use high-frequency radio devices and cannot be held responsible for any interference with a robot caused by them.

Special attention should be paid to the strong ambient light during the event, especially when using infrared or other optical devices. Furthermore, this light may vary between different tables and also even during a single match.

5. Identification tag

Tags are assigned to the robots in each match. These tags have a negligible weight and are placed on top of the opponent beacon or beacon support if there is no beacon.

The tags have the colour of the team and allow the audience to assign the robots to the teams.





ROBOMOVIES



... Rules... Rules... Rules... Rules... Rules... Rules... Rules... Rules... Rules... Rules...

G. Match procedure

The matches have a duration of 90 seconds.

Only two members of each team are allowed to access the stage and the backstage area.

1. The preparation phase

At first the playing elements are put in place according to the figures in the appendix.

When arriving at the playing table, the teams have 3 minutes to set up their robots and beacons.

Failing to meet this deadline may result in the team's disqualification (scratch) from that match. In that case the opponent will play the match alone.

If both teams completed the setup, the referees ask if the teams are ready for the match. From this moment on it is forbidden to touch their robots or beacons (except the starting cord) ! No objection regarding the playing elements or their placement will be accepted from this point on.

2. The match

The referees will give the signal to start the robots after a short countdown. It is forbidden to touch the robots, the beacons, the table and its elements unless it is explicitly authorized by a referee. This also includes pressing the emergency button! Failing to comply with that rule may result in a team's disqualification from that particular match (scratch).

Any elements leaving the table may not be returned.

After 90 seconds the robots must have stopped moving and switched off all actuators.

After the end of a match, **no one except the referees** is allowed to touch the robots or the playing elements. The referees count the points on a so called match sheet and explain them to the teams. (Please take a look at the next section on how to count points.) If both teams agree with the result, they sign the match sheet, take their robots and leave the stage.

If one team does not agree with the result of the match it may present its arguments **calmly**, while the robots stay in place. Please remember that only two members per team are allowed on stage. The decision of the referees is final.

In case of judging difficult situations, the referees can decide to replay or not the match.

If for example all robots are blocked, the referees may announce an early end of the match with both teams' affirmation.

A scratch of a team happened:

- when none of the robots of a team has completely left the starting area during the match
- when the emergency button has been pushed during the time of the match
- for other refereeing decisions.





ROBOMOVIES



... Rules... Rules... Rules... Rules... Rules... Rules... Rules... Rules... Rules... Rules...

3. The scoring

The referees will count the points for each team as follows:

a. The spotlight

2 points for each valid stand.

3 bonus points for each valid stand placed in a spotlight.

b. The clapperboards

5 points for each closed clapperboard.

c. The popcorn

1 point for each popcorn located in a popcorn cup that is located in a cinema or located in a popcorn basket.

d. The red carpet

2 points for each step of a walkway covered partially or totally by a red carpet.

4 bonus points for each walkway whose steps have all been covered partially or totally by a red carpet.

e. Climbing the red carpet steps

15 points if at least one of the robot of the team is in contact only with the top of the steps.

Penalties

A penalty leads to a **loss of 10 points** for the match it occurred in.

A negative score will be rounded to 0.

An element controlled by a robot does not score any points. A playing element is considered to be in the control of a robot if by moving the robot along its innate axis of locomotion the element is also moved.

Bonus points: 5 bonus points is given to all teams that are not "scratched", i.e. that have won or lost the match.

Reminder:



Penalties are intended to compensate for damages or disadvantages as a result of an incident during the match. A penalty situation is considered as a non-compliance with the rules and should remain the exception. A penalty may result in a scratch for the team. The referees will also pay attention to the cumulated penalties given during the qualification phases (regional, national and also European).





ROBOMOVIES



H. The contests

1. Forewords

The Eurobot^{Open}/Eurobot^{Open} Junior events are organized on three levels:

- In **Regional** events, where they exist (e.g. in France for Eurobot^{Open} Junior), a certain number of teams can qualify for the national finals.
- In **National** finals, four teams qualify for the European finals. *Be aware that the number of team that can qualify has changed since last year!*
- In the **European** final the teams qualified by their national finals meet in the same friendly spirit.

2. Approval

Before a robot can participate in a match it needs to be approved by a referee:

- In the **pre-approval** a referee verifies the robots' compliance with the rules. Therefore the robot should be able to demonstrate all action it is capable of.
- **Approval:** The robot(s) must demonstrate their ability to score at least one point under match conditions, i.e. in 90 seconds without the presence of an opponent team. The avoidance system and other equipment will also be tested in that phase.
- If the main robot and the secondary (optional) robot pass the tests, they are declared as approved. If only one out of two robots pass the approval this robot is can play the matches on its own.
- **Significant technical modifications after the approval:** If significant changes are made to a robot, e.g. in its function, structure or dimensions, a referee needs to be informed. That referee will reapprove the robot and redo some test if it is considered necessary.

3. Qualification phases

Each team should have the possibility of playing at least three matches during the qualification phase. The local organizers can also decide to play more matches which are normally organized in rounds. To choose the teams for the finals, a ranking is set up by using the accumulated points of each team during the qualification phase.

If two or more teams have the same number of points, the teams will be ranked by comparing their scores without considering the bonus points.

If teams still level, the referees may decide to organize extra matches. In that case, pairs of teams competing for the same ranking will be drawn by lot and the winner of the resulting matches will move on to the final round.

In the case of an odd number of teams, an opponent for the last team is drawn by lots. Points scored by the randomly chosen team will enter the ranking.



4. The finals

After the qualification phase, the first 8 or 16 teams (depending on the number of approved teams) will participate to the final phase according to the following figure:

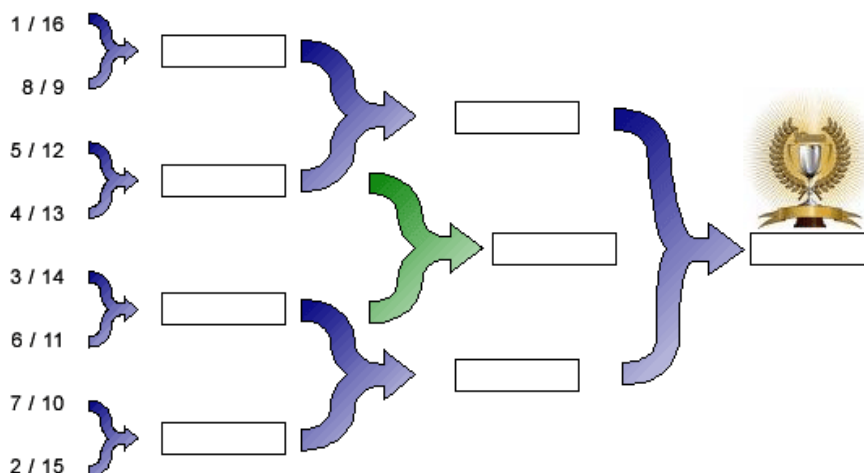

Figure 27: Schematic of the finals

In this phase the matches are played as knock-out matches, i.e. the winner moves on to the next round. If a winner cannot be determined (double scratch or draw) the match is replayed immediately. If the situation is still unresolved, the points during the qualification can be taken as a criterion to declare the winner.

The final match for the first place is played as “best of three”. The team that first wins two matches wins the match.

5. Qualification for the national finals

Where the regional competitions exist (e.g. in EurobotOpen Junior in France) the number of teams that can qualify for the national competition is proportional to the total number of teams on national level.

The results of the qualification rounds are used to select the teams for the national finals.

Final rounds can still be held to define the regional champion, but this champion is not necessarily qualified for the national competition!

At least one team received as special award (for example for creativity, fair play, best presentation, ...) and is also qualified for the national competition.

6. Qualification for the European finals

Each country participating in Eurobot^{Open} and/or Eurobot^{Open} Junior organizes a national competition to determine the teams qualified for the international phase. The top teams in the final rounds (not the qualification rounds) as well as the team who received a special award will qualify for the European finals.





ROBOMOVIES



... Rules... Rules... Rules... Rules... Rules... Rules... Rules... Rules... Rules... Rules...

In the case where no team receives a special awards, the top four teams will qualify for the European finals.



For questions and comments feel free to visit the forum on <http://www.planete-sciences.org/forums/> (sections Eurobot^{Open} and Eurobot^{Open} Junior)

A volunteer from the refereeing committee will answer your questions there. News and more information about Eurobot^{Open} and Eurobot^{Open} Junior are available at our website www.eurobot.org. It also contains links to your local organizations

The whole organization team of Eurobot^{Open} and Eurobot^{Open} Junior wishes you a lot of fun and success for the coming months, and looks forward to seeing you soon around a playing field!

Robotic Regards,
The Eurobot^{Open} and Eurobot^{Open} Junior organization committee.



I. Appendix

1. [Playing area view from top](#)

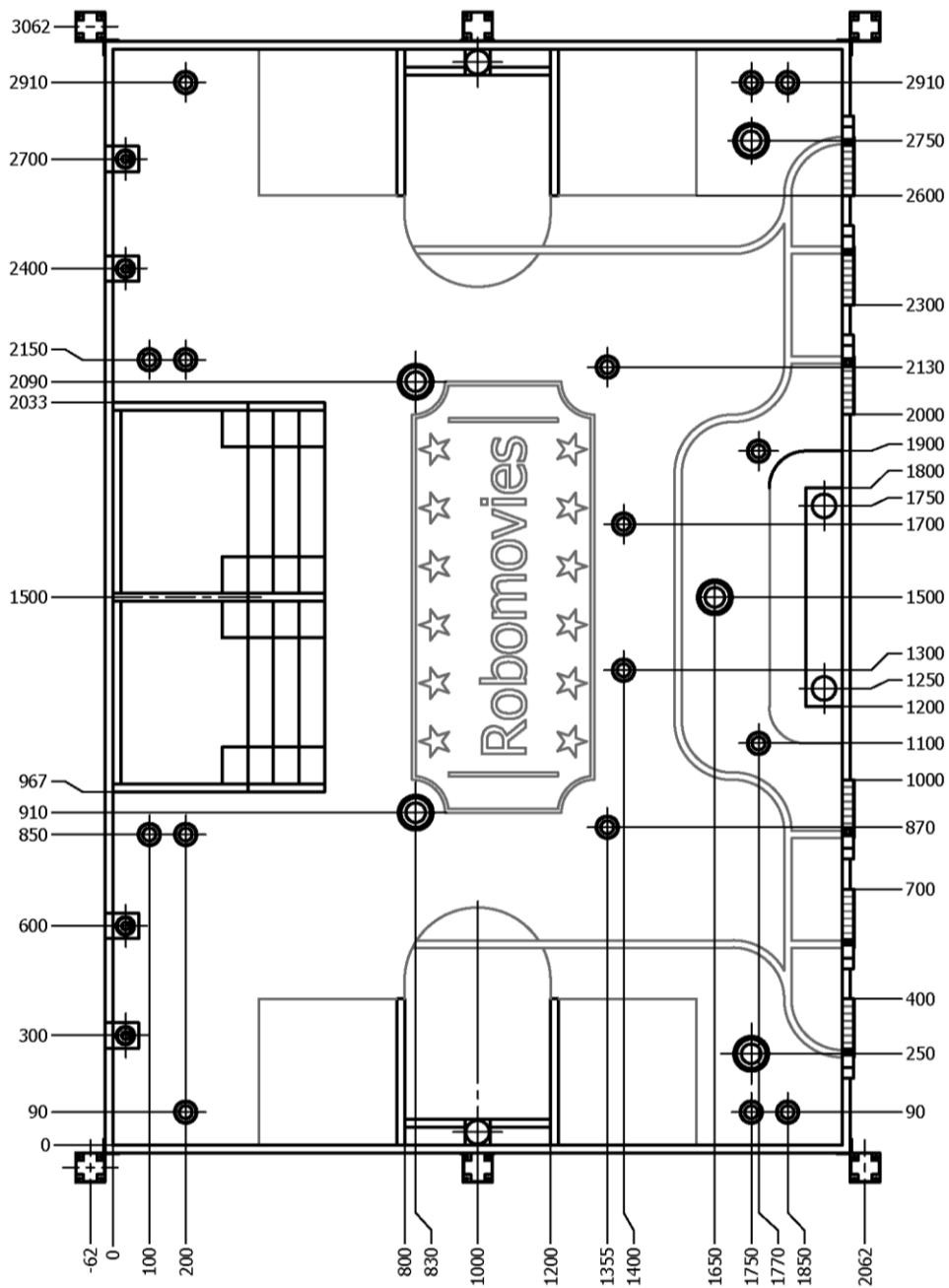

... Rules... Rules... Rules... Rules... Rules... Rules... Rules... Rules... Rules... Rules...

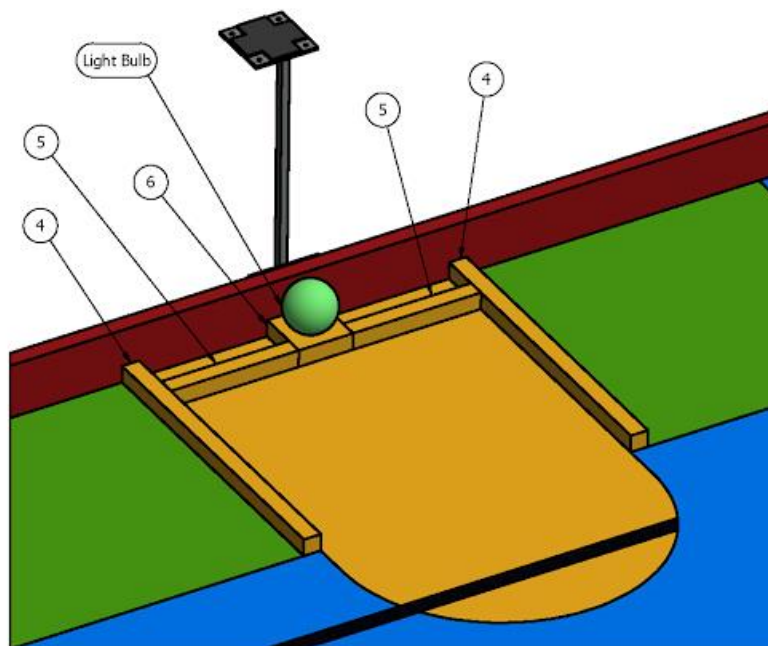
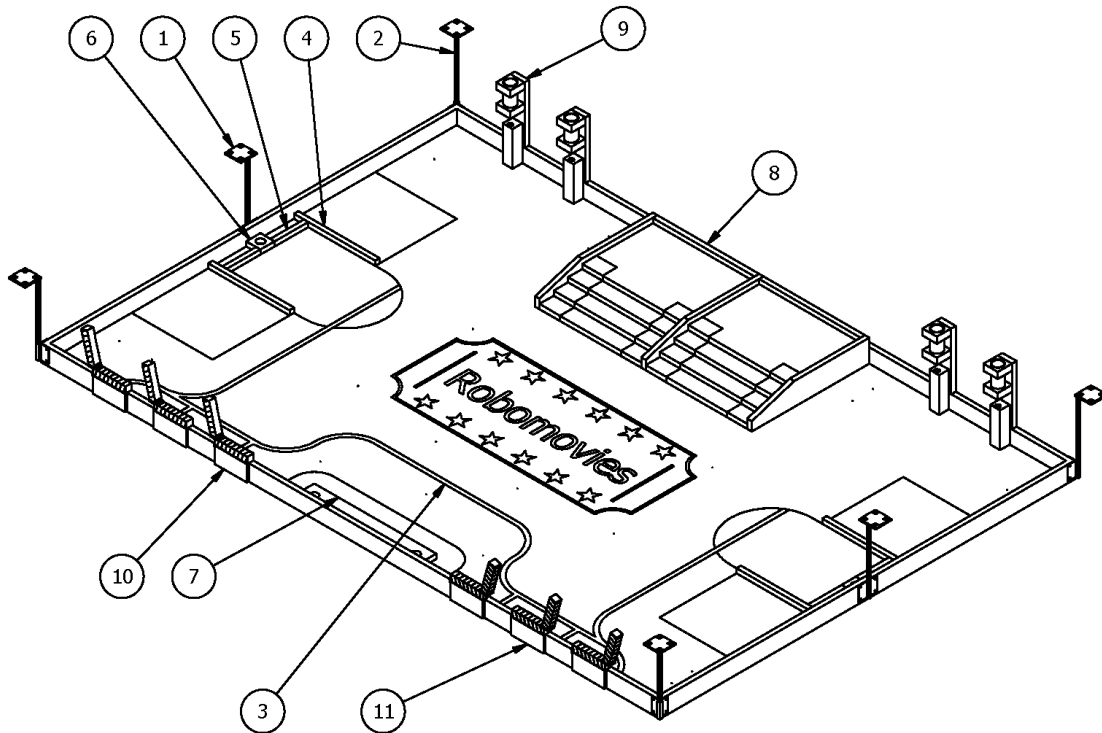

... Rules... Rules... Rules... Rules... Rules... Rules... Rules... Rules... Rules...

2. Table (Painting)

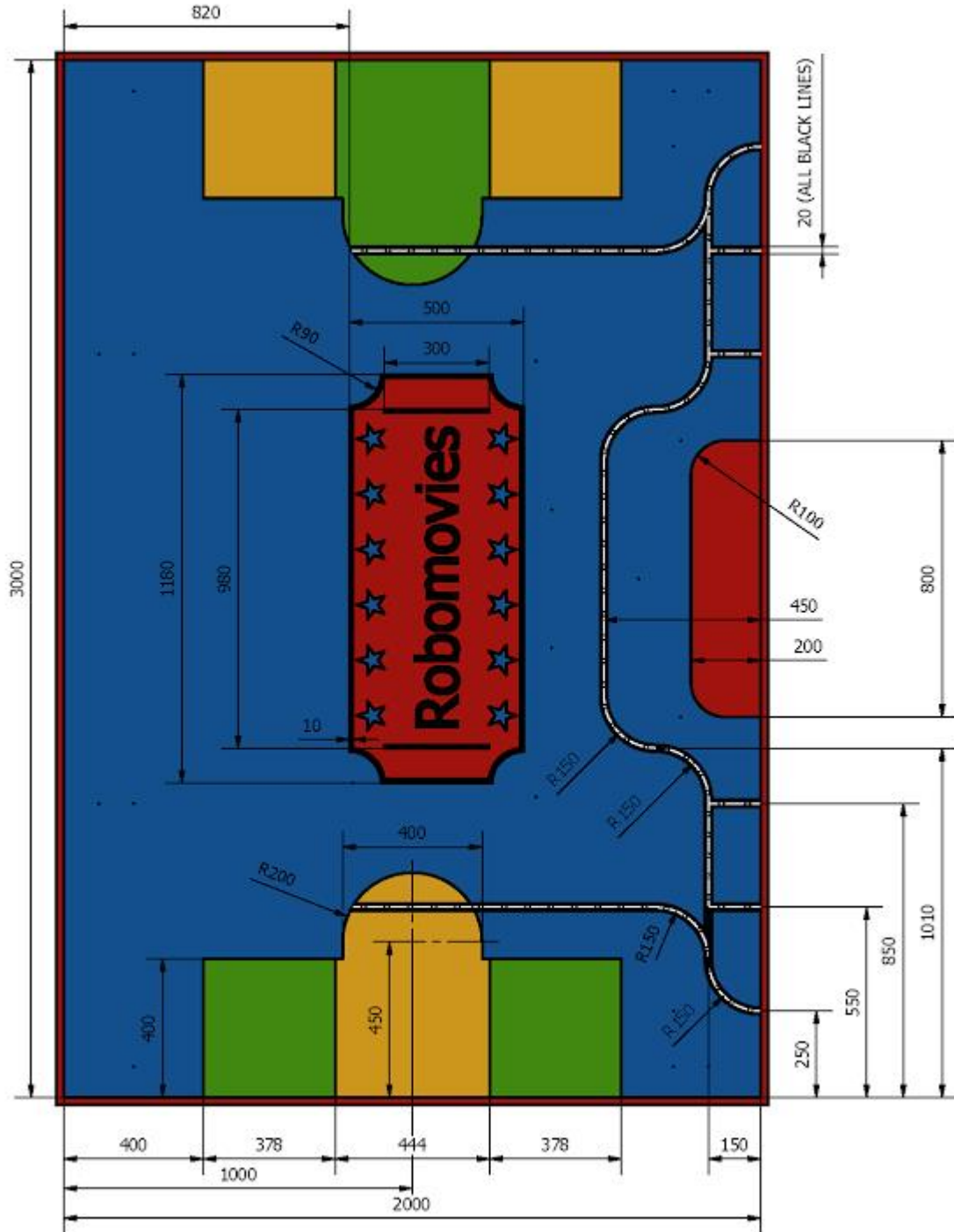

3. Starting area

4) Starting area 1 (2x Green, 2x Yellow)

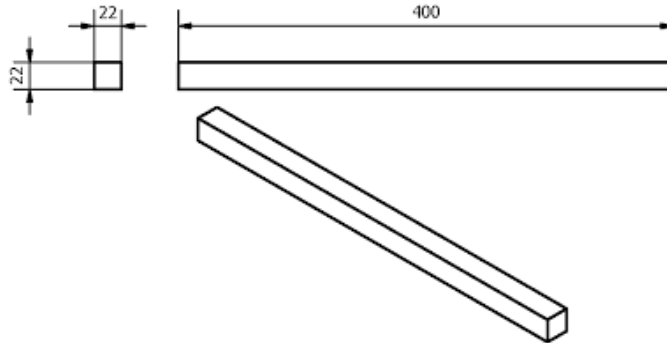

5) Starting area 2 (2x Green, 2x Yellow)

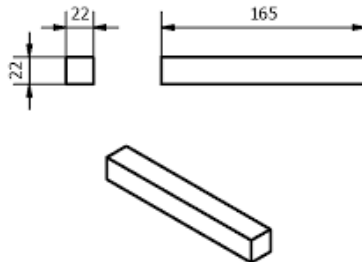

6) Starting area 3 (1x Green, 1x Yellow)

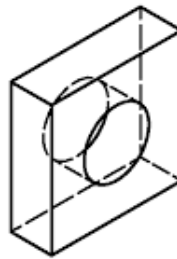
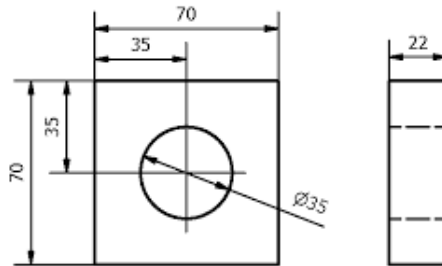

4. Platform

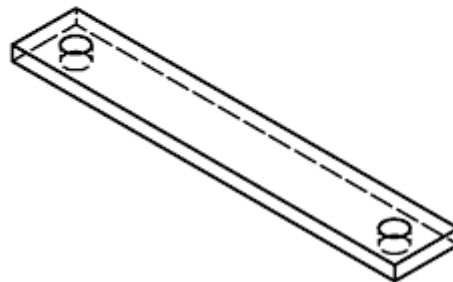
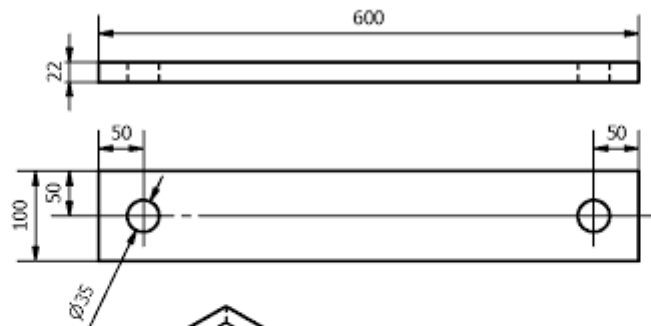

5. Stairs





... Rules... Rules... Rules... Rules... Rules... Rules... Rules... Rules... Rules...

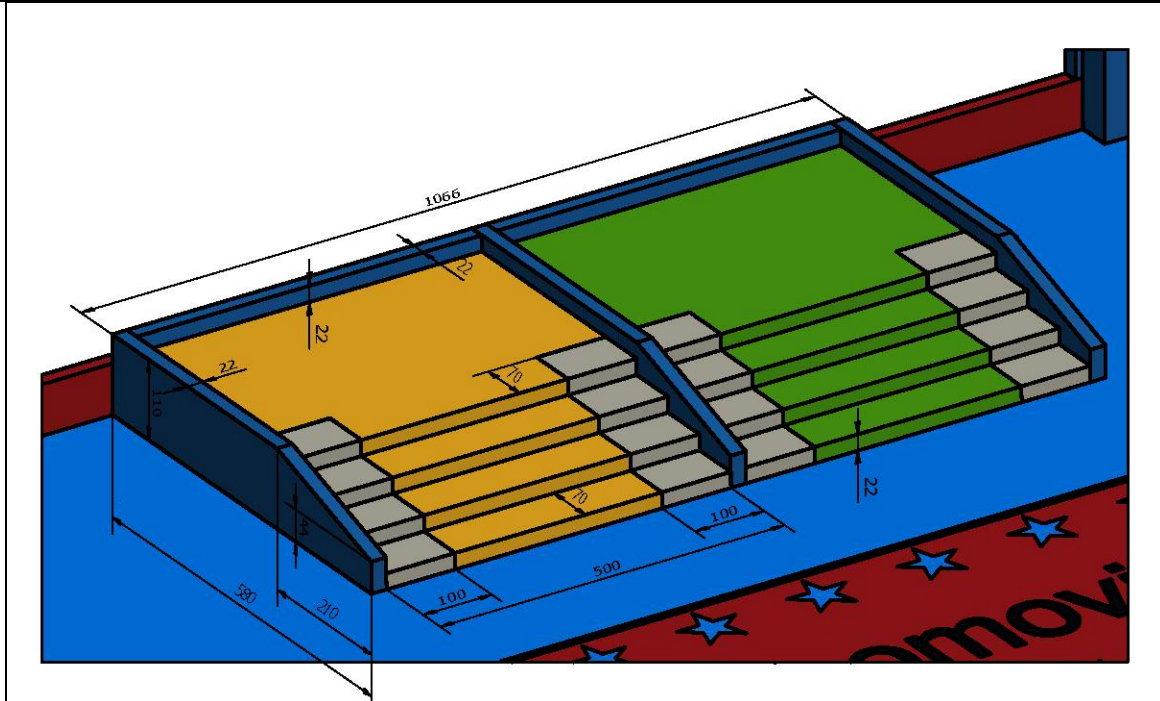

... Rules... Rules... Rules... Rules... Rules... Rules... Rules... Rules... Rules...

6. Popcorn machine

9) Popcorn machine (4x Blue)

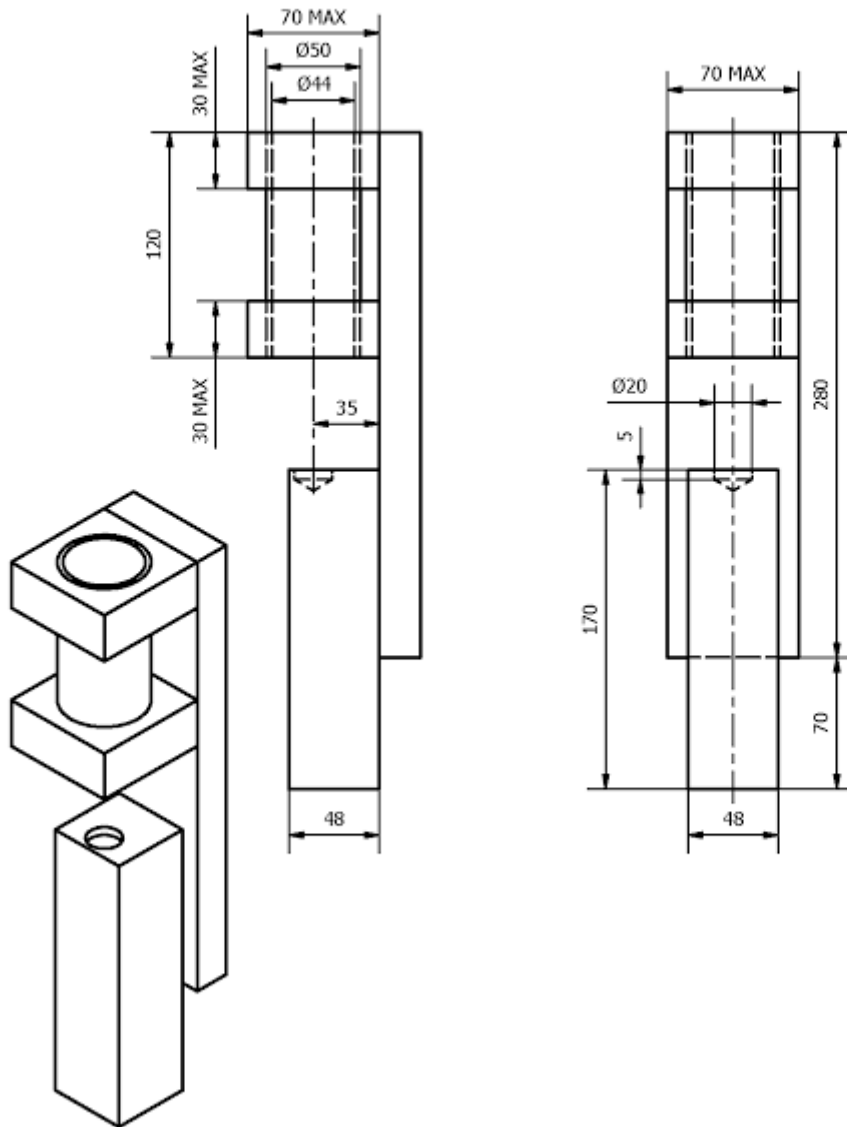

The popcorn machine tube is supported at the top and bottom by two elements whose shape can vary according to the organizer but whose occupation does not exceed a block of 70 * 70 * 30 mm.



... Rules... Rules... Rules... Rules... Rules... Rules... Rules... Rules... Rules... Rules...

7. Clap left

12) Clap Left (1x Green, 2x Yellow)

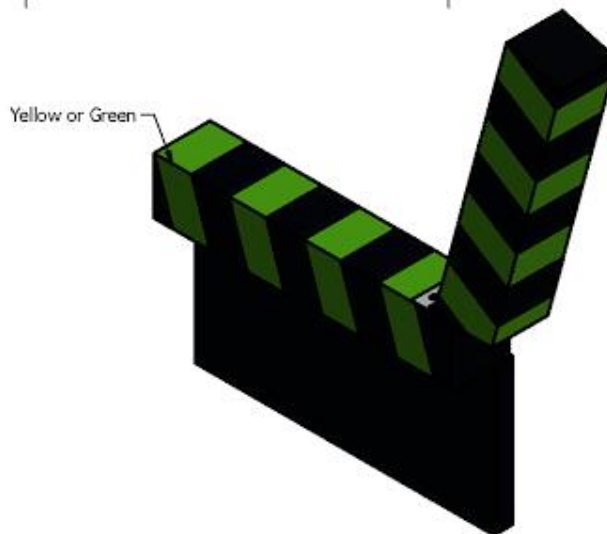
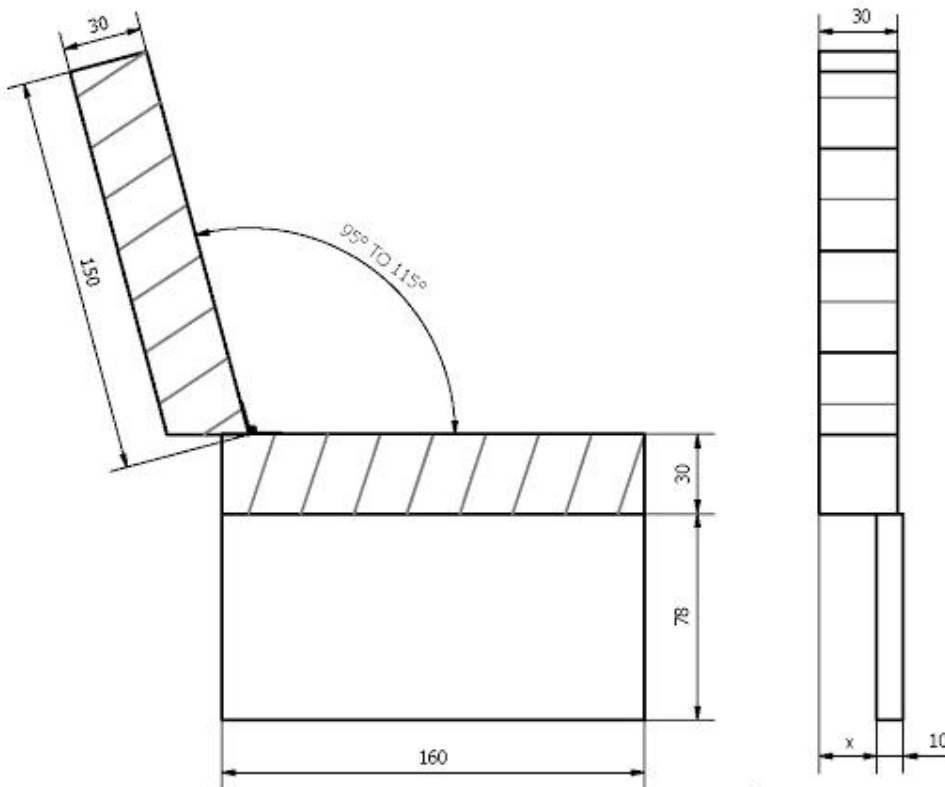



ROBOMOVIES



... Rules... Rules... Rules... Rules... Rules... Rules... Rules... Rules... Rules... Rules...



... Rules... Rules... Rules... Rules... Rules... Rules... Rules... Rules... Rules... Rules...

8. Clap right

13) Clap Right (2x Grey, 1x Yellow)

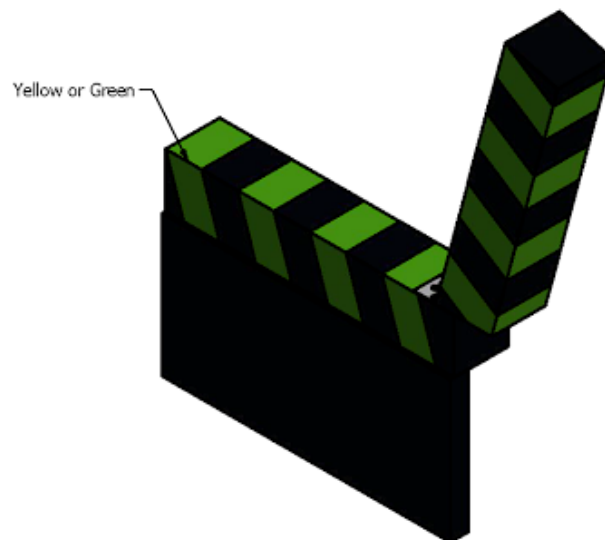
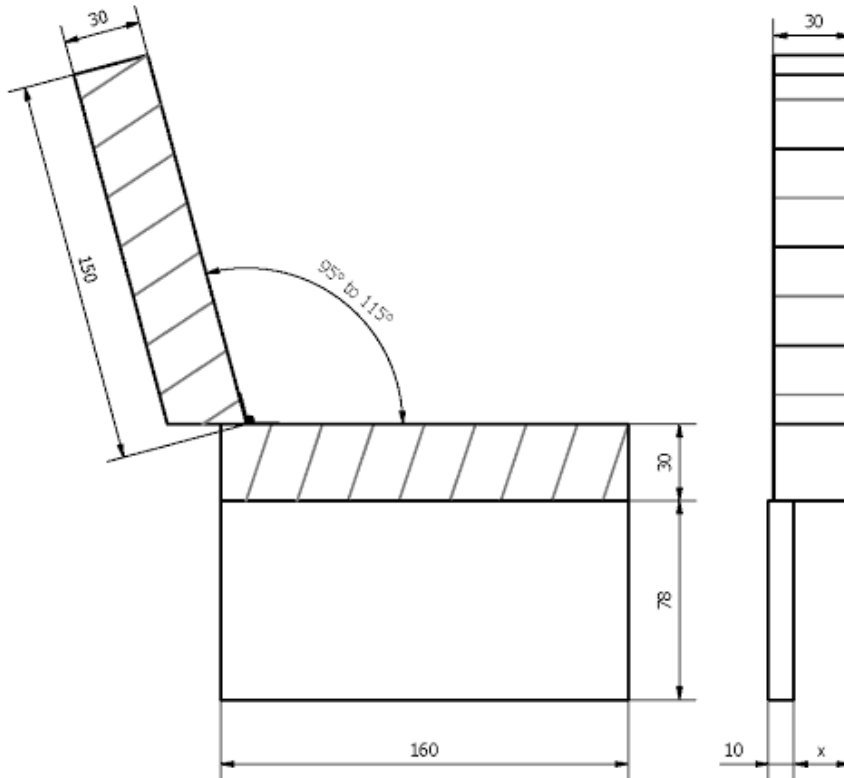

9. Cup

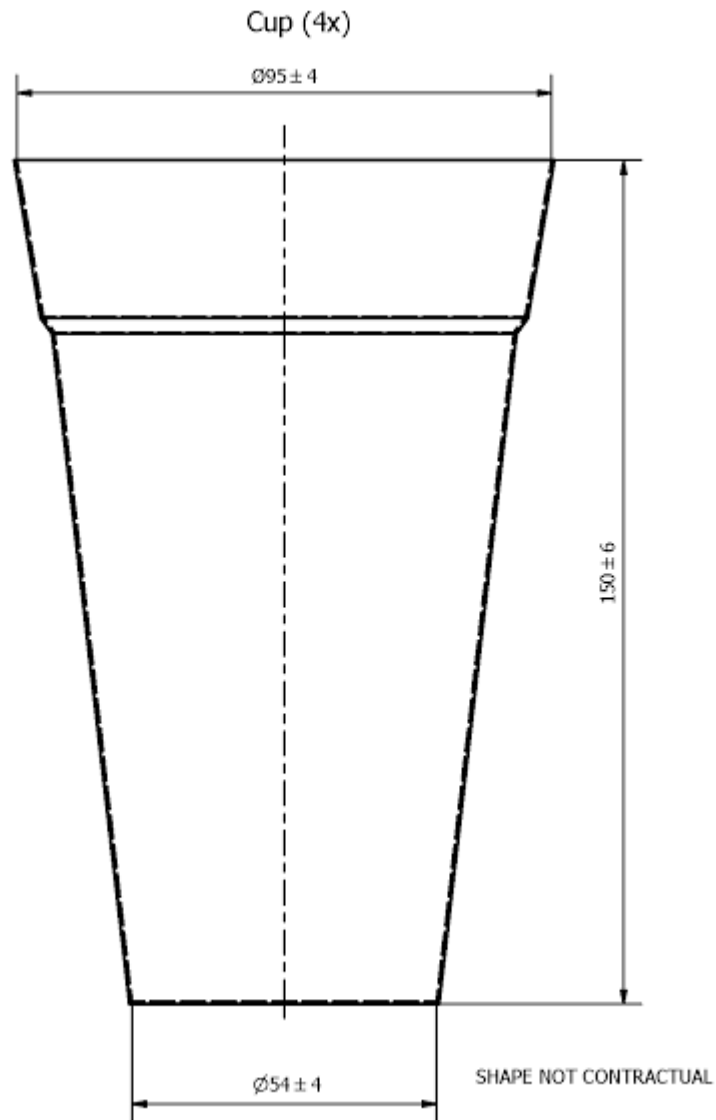

10. Stand

Stand (8x Green, 8x Yellow)

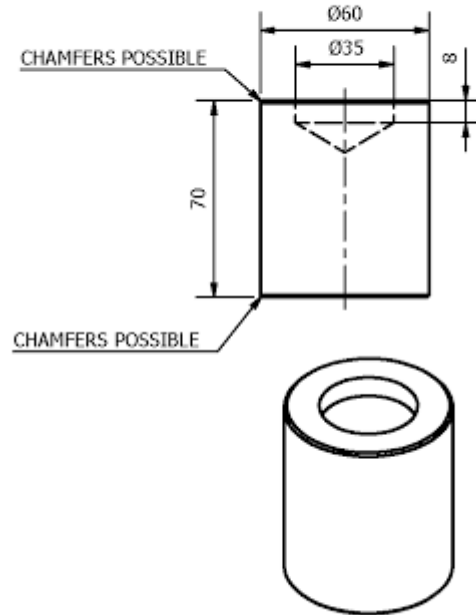

11. Beacon support middle (specific Eurobot^{Open})

1) Beacon support middle (2x)

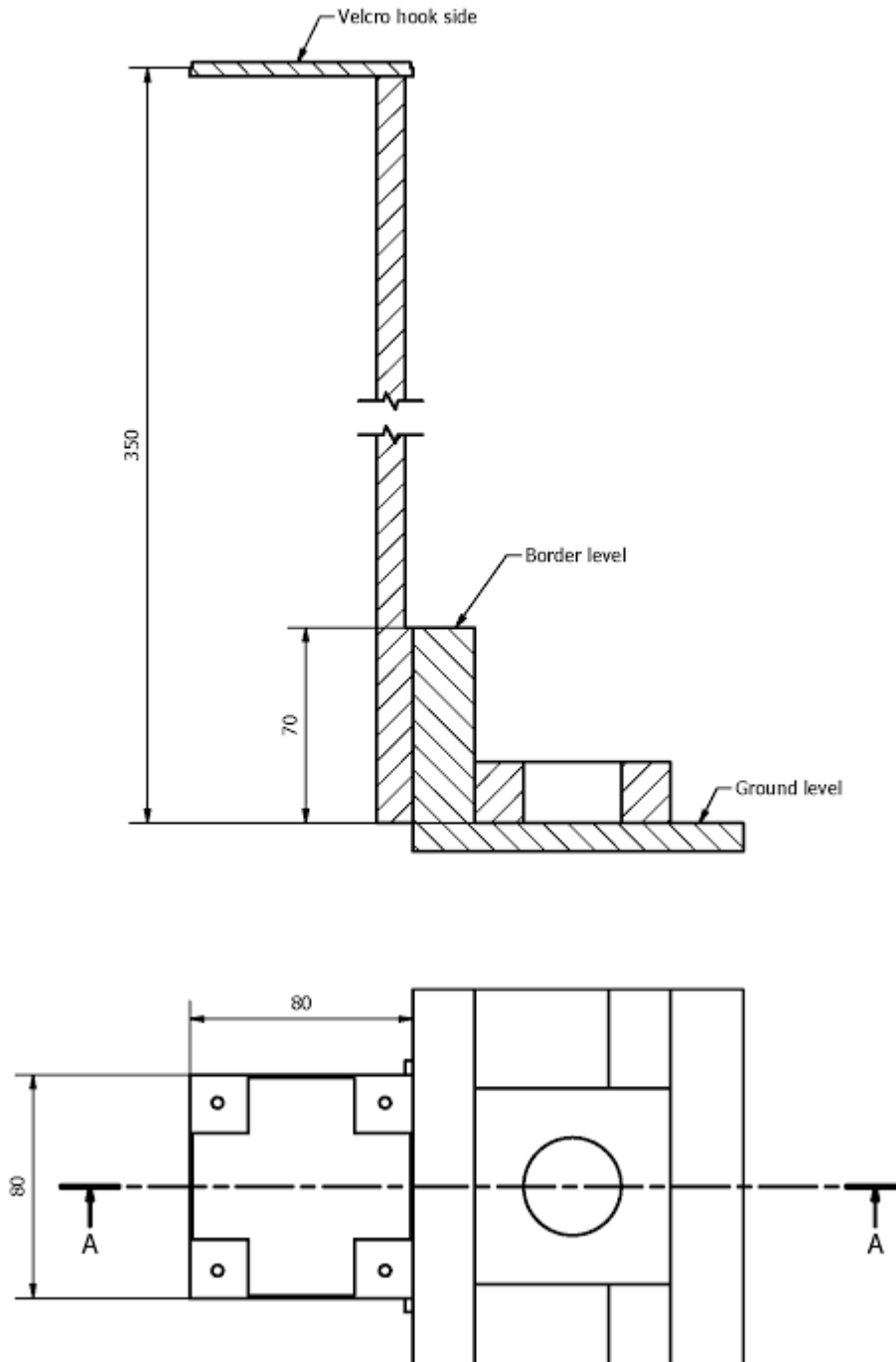



EUROBOT

ROBOMOVIES



Page 45

... Rules... Rules... Rules... Rules... Rules... Rules... Rules... Rules... Rules... Rules...



YVERDON-LES-BAINS

12. Beacon support corner (specific Eurobot^{Open})

2) Beacon support corner (4x)

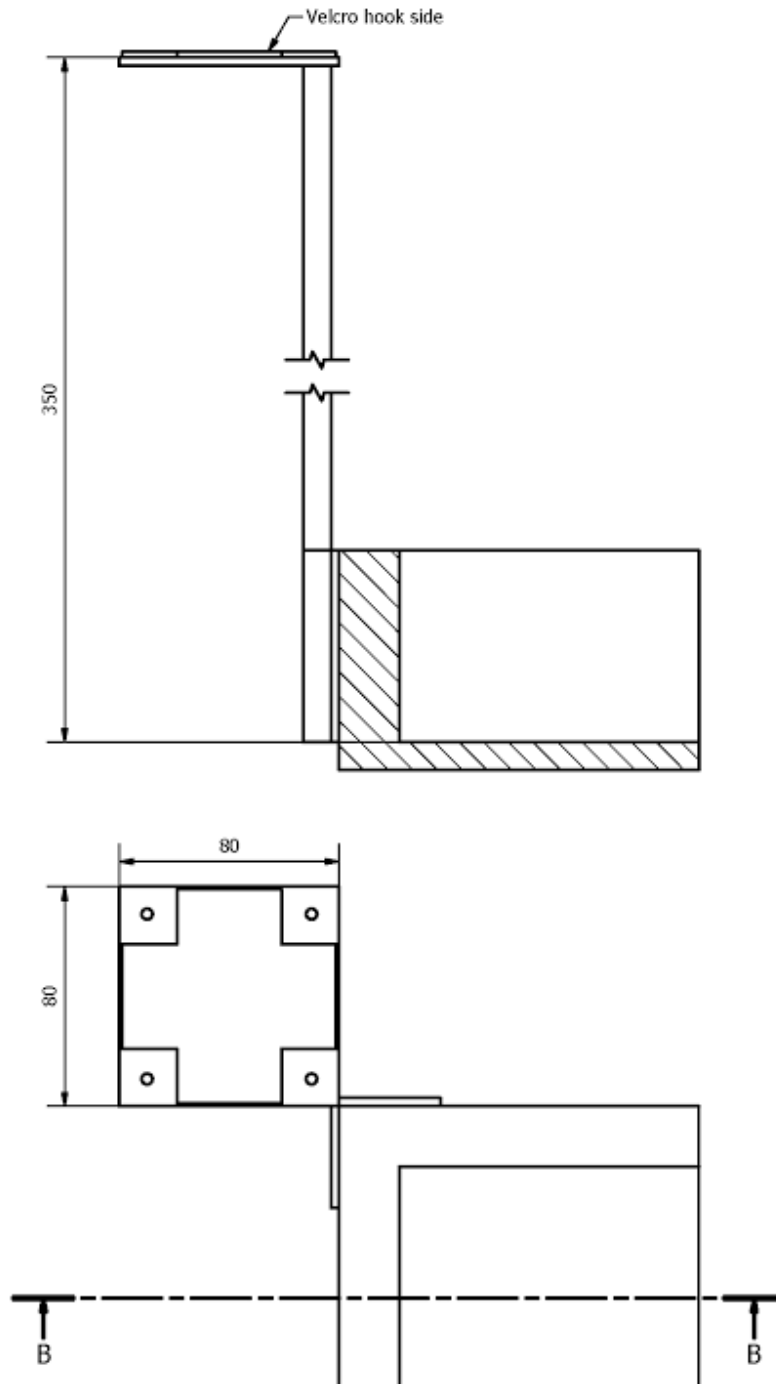

13. [Painting references](#)

	Colour	Reference
Ground, popcorn machine, steps borders, ticket's stars	Sky blue	Ral 5015 Mate
Team A colour	Traffic yellow	Ral 1023 Mate
Team B colour	Yellow green	Ral 6018 Mate
Playing area borders, ticket drawn in the middle of the playing area	Traffic red	Ral 3020 Mate
Clapperboards, black lines	Dark black	Ral 9005 Mate
Walkways	Flint grey	Ral 7032 Mate

14. [Material references](#)

Material references for the elements available on the playing table:

Element	Material	Remark
Popcorn cups	Rigid transparent plastic	
Popcorn	Polystyren ball	Diameter: 40 mm
Popcorn machine tube	Transparent PMMA	
Popcorn machine support	Wood or transparent PMMA	Unkown density
Light bulb	Tennis ball	Diameter: between 63,5 and 66,7 mm
Stands	Wood	Unkown density
Red carpet	Tissue	350 mm * 100 mm
Clapperboards	Wood	Unkown density

The wood's density can change from one a country to another. It is highly recommended that the team tries different types of wood as the weight can vary change in a significant way.

The transparent plastic's density can change from one a country to another.

